



Platinum, Escape X & Deck Spas

2026 Owner's Manual XL Heater Versions

Hydrotherapy to Heal Minds and Bodies™





Congratulations, You are now the proud owner of the finest spa built. Now you will experience true comfort and relaxation as you never had before. We at Cal Spas® focus on quality, design, and comfort to create a truly luxurious experience like no other. Welcome to the Cal Spas family.

It is important that you register your Cal Spas product as soon as possible. This can be done by taking a few minutes to complete an online registration form on our website. Allowing us to efficiently help you with parts, support, or other inquiries.

<https://calspas.com/register-your-spa.php>

Locating the Spa Serial Number

You will need your spas serial number, This serial number is placed on the exterior of the spa. The plate is placed on the lower right hand side when facing the front of the spa. This serial number is unique to your spa, and can be used to order parts, file a warranty claim, and is used in the registration process to activate your spas warranty.

Model: _____

Spa Serial Number: _____

Purchase Date: _____

Dealer's Phone Number: _____

Dealer's Address: _____

Contact Information

For customer service or service technicians, please contact your authorized dealer immediately. If you need additional information and/or assistance, contact

**Lloyd's Material Supply Company, Inc.
Customer Service Department
1462 East Ninth Street
Pomona, CA 91766**

Toll Free: 1-800-CAL-SPAS
Fax: 1-909-629-3890

Copyright 2026 Lloyd's Material Supply Company, Inc. All rights reserved.
Duplication without written consent is strictly prohibited.
Cal Spas®, Adjustable Therapy System™, ATS™, Cal Premium™, Cal Select™, Cal Stone™, XL™ Heater, and Ultimate Fitness Spa Series™, are registered trademarks. Due to continuous improvement programs, all models, operation, and/or specifications are subject to change without prior notice.

LTR.2026.1010.XL
12/4/2025 Rev E

Table of Contents

Important Safety Instructions	4	Touch 4+ Control Panel	52
Preparing for Your New Portable Spa	6	Navigating Menu Icons	52
Foundation Planning Requirements	7	Priming Mode	54
240 Volt Electrical Installation	7	Connecting to Wifi	52
Removing Shipping Materials	8	Setting Time of Day	58
Clearance Requirements	9	Setting Filter Cycle	59
Opening for Electrical Access	9	Adjust Water Temperatures	60
Snap in Cabinet Panel	9	Activating Jets/Pumps	60
GFCI Wiring Diagram for USA/Canada	12	Adjusting Screen Brightness	61
Filling and Powering Up the Spa	13	Set Heat Mode	62
Priming the Pump	17	Diagnostics	63
XL Heater Operation	18	General and Heater Related Messages	64
Spa Control Systems		Sensor Related Messages	65
Spa Touch 2 Control Panel	20	Reminder Messages	66
Main Screen & Legend	21	Spa Operations	
Adjusting Temperature & Navigation	22	Electrical Power Efficiency Tips	69
Changing Languages	23	Jets and LED Lighting	69
Priming Mode & Temp Sensors	25	Diverter, Air Venturis, and Waterfalls	70
Freeze Protection, & Ozonator (option)	25	ATS Therapy Seat System (Option)	71
Pumps, Navigation & Selection	26	Throttle Seat VMS Massage Seat	72
Navigation Between Pages	27	Water Clarity	
Settings Screen	27	The Four Steps for Water Clarity	76
Dual Temperature Ranges	28	Water Quality Terms and Definitions	77
Ready in Rest Mode	28	Water Testing Methods	78
Setting the Time of Day	28	Adding Chemicals to the Spa	78
Adjusting Filtration	29	Balancing Water Chemistry Levels	79
Panel Unlock/Lock	29	Sanitation and Shock	80
Utilities & Fault Log	30	Filtration and Cleaning	82
General Messages & Heater Messages	32	General Water Care Schedule	83
Sensor & System Related Messages	33	Generic Names for Chemicals	83
Reminder Messages	34	Common Water Chemistry Questions	84
Touch 4 Control Panel	35	Do's and Don't's	85
Main Screen Legend	36	Bather Loads	86
Spa Status	37	Ozonator	86
Setting the Time of Day	38	Troubleshooting Water Clarity	86
Setting the Temperature	39	Chemical Abuse	87
Run Spa Devices (Pumps, Blowers, etc)	40	Cleaning and Maintenance	
Set Filter Cycle Times	41	Removing & Re-seating Pillows/Jets	88
Restrict Panel (Lock/Unlock)	42	Spa Cover and Locking System Installation ...	89
Ozone, Freeze Protection, & Clean Up Cycle	44	Draining Your Portable Spa	91
Diagnostics Screen	45	Winterization (Cold Climate Draining)	92
Heat Mode & Heat Settings	46	Cleaning and Replacing the Filter	92
Temp Range	47	Vacation Care	92
Settings Screen	48	Cleaning Your Spa	93
General & Heater Related Messages	50	Using the Freedom Sound System	93
Sensor Messages	51	Appendix	
Reminder Messages	51	Ordering Replacement Parts	94
		Replacement Parts	95
		Basic Troubleshooting	101
		Warranty Information	105

IMPORTANT SAFETY INSTRUCTIONS



READ AND FOLLOW ALL INSTRUCTIONS CAREFULLY

When using and installing this spa, basic safety precautions should always be followed, including.



Danger: RISK OF SEVERE INJURY OR DROWNING!

- NO DIVING, diving may result in injury or death.
- Do not allow children to be in or around the spa unless a responsible adult supervises them.
- Keep the spa cover on and locked when not in use
- See instructions enclosed with your cover for locking procedures.



Danger: SUCTION ENTRAPMENT HAZARD, RISK OF SEVERE INJURY OR DROWNING!

Suction in suction fittings when broken, damaged, cracked, or unsecured can cause severe injury and or death due to the following entrapment hazards.

- **Body Entrapment:** A negative pressure applied to a large portion of the body or limbs can result in entrapment.
- **Hair Entrapment:** Hair can be sucked in or caught within the suction fitting.
- **Evisceration/Disembowelment Entrapment Risk:** Negative pressure applied directly to the intestines through a damaged/unprotected suction outlet. This can result in Evisceration/Disembowelment.
- The suction fittings in this spa are sized to match the specific water flow created by the pump. Should the need arise to replace the suction fittings, or the pump, be sure the flow rates are compatible.
- The suction fitting is made with chemical resistant plastic, that will last over a finite period of time. This component will degrade and become brittle after constant exposure to sanitizers. When performing maintenance on the spa, inspect suction fittings for any cracks or damage.
- When the spa is in operation, suction is created within the suction fittings. Persons within the spa should not be leaning on, stepping on, or making contact with suction fittings.



Danger: RISK OF SEVERE INJURY FROM ELECTRIC SHOCK OR DEATH FROM ELECTROCUTION.

- Install the spa at least 5 feet (1.5 meters) from all metal surfaces. As an alternative, a spa may be installed within 5 feet (1.5 meters) of metal surfaces if each metal surface is permanently bonded by a minimum of 8 gauge AWG solid copper conductor to the outside of the spas control box.
- DO NOT permit any external electrical appliances, such as lights, telephones, radios, television, etc, within 5 feet (1.5 meters) of the spa. Never attempt to operate any electrical device from inside the spa.
- Replace any damaged power cord immediately.
- Never bury any power cord, a proper conduit must be used.
- Connect to a proper grounding-type receptacle or to a proper grounding post in the GFCI and breaker.



Warning: RISK OF HYPERTHERMIA (OVER-HEATING) CAUSING SEVERE INJURY, BURNS, WELTS, OR DEATH

- Water temperature in excess of 104°F (40°C) may be detrimental for your health.
- The spa water should never exceed 104°F (40°C). Water temperatures between 100°F (38°C) and 104°F (40°C) are considered safe for a healthy adult.
- Lower water temperatures are recommended for young children, and when the spa use exceeds 10 minutes.
- Before using the spa, the user should measure the water temperature since the tolerance of water temperature regulating devices varies.
- **Do not use the spa if drugs, alcohol, or prescription medications were consumed before or during use. In an altered state of mind, the human body can not react properly to changes in temperature. This increases your risk of hyperthermia, injury, drowning, or death.**

 **Warning: REDUCE RISK OF HEAT RELATED INJURY OR DEATH**

- Prolonged exposure to hot air or water can induce hyperthermia. Hyperthermia occurs when the internal temperature of the body reaches a level between 3°F (2°C) to 6°F (4°C) above the normal body temperature of 98.6°F (37°C). While using warm spa water has many health benefits, its important to make sure that your body's core temperature does not rise above 103°F (39.5°C).
- High water temperatures have a high potential for causing fetal damage during pregnancy. Women who are pregnant, or think they are pregnant should always check with their physician prior to spa usage.
- The use of alcohol, drugs or medication before or during spa use may lead to unconsciousness, with the possibility of drowning.
- Persons suffering from obesity, a medical history of heart disease, low or high blood pressure, circulatory system problems or diabetes should consult a physician before using the spa.
- Persons using medications should consult a physician before using the spa since some medications may induce drowsiness or impair judgment. Other medications or drugs may affect heat rate, blood pressure and circulation.

 **HYPERTHERMIA**

- Symptoms of excessive hyperthermia include dizziness, lethargy, drowsiness and fainting. The effects if excessive hyperthermia may include:
 - Failure to perceive heat
 - Failure to recognize the need to exit the spa
 - Unawareness to impending hazards
 - Fetal damage to pregnant woman
 - Physical inability to exit spa
 - Unconsciousness

 **Swim Spa Temperatures**

- When using a swim spa or deck spa for exercise or for leisurely swimming, never set the swim spa water temperature above 80°F. Temperatures above 80°F can hinder the bodies ability to cool down and cause unnecessary cardiovascular stress.

 **WARNING:** People with infectious diseases or diarrhea should not use a spa or hot tub.

 **WARNING:** To avoid injury, exercise caution when entering or exiting the spa/swim spa.

 **WARNING:** Do not use the spa or swim spa immediately following strenuous exercise.

 **WARNING:** Prolonged immersion in a spa or hot tub may be injurious to your health.

 **CAUTION:** Maintain water chemistry in accordance with the manufacture's instructions.

 **WARNING: NO DIVING, diving may result in injury or death.**

 **WARNING:** The filter lid is a cosmetic item, do not sit or place heavy objects on the filter lid.

READ AND SAVE THESE INSTRUCTIONS



Preparing for Your New Portable Spa

Pre-Delivery Checklist

Most cities and counties require permits for exterior construction and electrical circuits. In addition some communities have codes requiring residential barriers such as a fencing and/or self closing gates on property to prevent children unsupervised access to the property by children. Your dealer can provide information on which permits may be required and how to obtain them prior to the delivery of the spa.

Planning the Best Location

Safety First

Do not place your spa within 10 feet (3m) of overhead power lines.

Consider How You Will Use Your Spa

How do you intend to use your spa will help you determine where you should position it. For example will you use your spa for recreational be sure to leave plenty of room around it for activity. If you will use it for relaxation and therapy, you will probably want to create a specific mood around it.

Plan for Your Environment

If you live in a region where it snows in the winter or rains frequently, place your spa near a house entry. BY doing this, you will have a palace to change clothes and not be uncomfortable.

Consider Your Privacy

In a cold weather climate, bare trees won't provide much privacy. Think of your spa's surroundings during all seasons to determine your best privacy options. Consider the view of your neighbors as well when you plan the location of your spa.

Before Delivery

- Plan your delivery route
- Choose a suitable location for the spa
- Lay a 5-8 cm concrete slab
- Install dedicated electric supply

After Delivery

- Place spa on Slab
- Connect electrical components

Provide a View with Your Spa

Think about the direction you will be facing when sitting in your spa. Do you have a special landscaped area in your heart that you find enjoyable? Perhaps there is an area that catches a soothing breeze during the day or a lovely sunset in the evening.

Keep You Spa Clean

Think about the direction you will be facing when sitting in your spa. Do you have a special landscaped area in your heart that you find enjoyable? Perhaps there is an area that catches a soothing breeze during the day or a lovely sunset in the evening.

Consider How You Will Use Your Spa

Make sure the spa is positioned so that access to the equipment compartment (front panel) and all side panels are not blocked.

Many people choose to install a decorative structure around their spa with any type of gazebo, remember to allow access to service. It is always best to design special installations so that the spa can still be moved, or lifted off the ground

Preparing a Good Foundation

7

Note: We strongly recommend that a qualified, licensed contractor prepare the foundation for your spa. Damage caused by inadequate or improper foundation support is not covered in your warranty. It is the responsibility of the spa owner to provide a proper foundation for the spa.

Your spa needs a solid and level foundation. The area that it sits on must be able to support the weight of the spa, with water and occupants who use it. If the foundation is inadequate, it may shift or settle after the spa is in place, causing stress that could damage the spa shell and finish. Place the spa on a elevated 3 to 4"/30 cm concrete slab. Pavers, gravel, brick, sand, timbers, or dirt foundations are not adequate to support the spa, if you are installing the spa indoors, pay close attention to the flooring beneath it. Choose flooring that will not be damaged or stained by treated water. if you are installing your spa on an elevated wood deck or other structure, it is highly recommended that you consult a structural engineer or contractor to ensure the structure will support the weight of 150lbs per square foot (732 Kg/m²)



240 Volt Electrical Installation

Note: These instructions describe the only acceptable electrical wiring procedure. Spas wired in any other way will void your warranty and may result in serious injury. The electrical circuit must be installed by an electrical contractor and approved by a local building or electrical inspector. Failure to comply with state and local codes may result in a fire or personal injury, and will be the sole responsibility of the spa owner.

All 240V spas must be permanently connected (Hard Wired) to the power supply. When installed in the united states, the electrical wiring of the spa must meet the requirements of the NEC 70 and any applicable local, state, and federal codes. The power supplied to the spa must be on a dedicated GFCI protected circuit as required by the NEC 70 with no other appliances to lights sharing the power. Use copper wire with THHN insulation. DO NOT USE ALUMINUM WIRE. Copper wire must be used for your GFCI circuit, wires that run over 100 feet must increase the wire gauge to the next lower number. For example: a normal 50 amp GFCI with four #6 AWG Wire must increase wire gauge size to the next lower number, in this example #6 AWG to #4 AWG if the circuit is longer than 100 feet, would require four #4 AWG copper wires.



Your Cal Spa is wrapped with a white shrink wrap designed to protect the acrylic shell from scratches and damage. Thoroughly inspect the plastic wrapping for any tears and or damage that may have occurred during shipping. It is expected to see some scuffs or small tears at the base and corners of the spa, as the spa is pushed and shifted around in transport.

Use a stainless steel cleaner or a damp microfiber towel to remove any residue or dust from the plastic wrapping if your spa is equipped with corners that have a stainless steel finish. Never spray directly onto the stainless steel trim or decor, spray onto a microfiber towel and wipe clean.



Depending on the type of spa, a piece of wood is placed on the side panels of the spa to protect it in shipping. The wooden supports are installed with several $\frac{7}{16}$ " (11mm) bolts, once the spa is in its final resting place, remove these with an 11mm socket.

While you are planning where to locate your spa, you need to determine how much access you will need for service.

All spa models require a minimum of three feet (one meter), of access to all sides of the spa for potential service. For this reason, the spa should never be placed in a manner where any side is permanently blocked. Examples include placing the spa against a building, structural posts, columns, walls, fences, or raised embankments.

If the spa is surrounded by a deck, ensure that there is easy access for service or repair. Decks should have the ability to be accessed or removed easily, some decks are built in segments for easy removal.

Spas require access in all sides in case they need service or repair. Additional service costs can be applied by the servicing dealer if a crane or additional manpower and equipment is needed to access the internals of the spa.

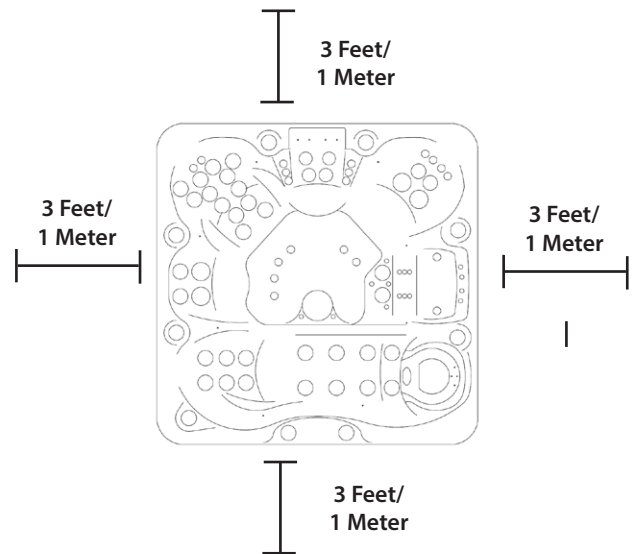

Opening the Front Panel For Electrical Access

Cal Spas are designed with innovative snap in panels and corners. In order to access the control box for electrical hook up, plumbing, or pumps inside of your spa, you will need to remove the corner panels and the front panel. The following tutorial is designed to illustrate the process of removing/re-installing any corner panel, and any side panel.



Caution: Pinch Points.

When snapping panels back into place your spa, be cautious of your hand position. Avoid placing your fingers or hands over the edges of corners or panels, it may result in injury once panels lock into place.

Before starting, make sure you wear gloves when removing any panel from your spa.



Step 1

In order to remove the front panel, the front corners of the spa must be removed prior to removing the front panel.

Note: Spa corners use support screws as well. Remove the screws from the corners. Do not pull on corners held down by any screw.



Step 2

Once the corner is removed, place aside with great care of not bending or stepping on the corner. Repeat the removal process with the remaining corner(s) based on your service access needs.

Step 3

Once both corners are removed, place one hand under the front panel and one hand on either corner.

Once prepared, pull both the center and your chosen corner at the same time to release the panel.

Caution: Brace for the weight of the panel once it is removed. Failure to do so can result in injury such as pinched fingers, cuts, or other injuries.



Step 4

Once the panel is removed, use the wooden support boards to move your panel around if needed.

Note: Do not move your spa panel using the white clamp in mechanism.



Step 5

Once the front panel has been removed, your electrician or contractor may perform the necessary electrical work to power the spa.

Once the required work is completed, retrieve the panel and align the cabinet mounted plastic clamp with the bottom spa mounted plastic retainer.

Note: In order for the panel to align, the plastic clips must be leveled with each other. If the panel is misaligned, remove and reinstall the panel.

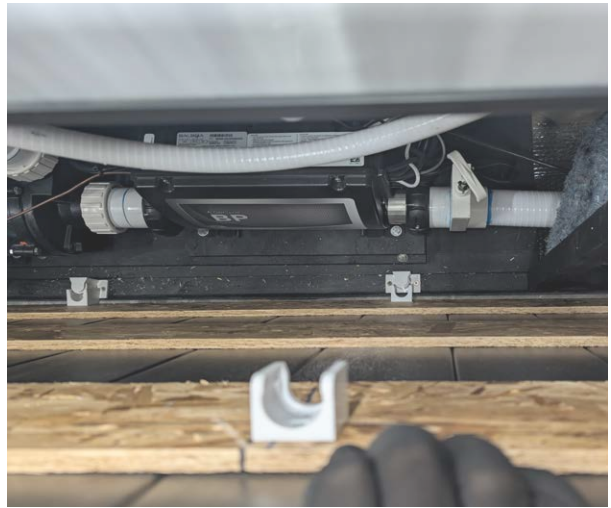

Step 6

Once the panel is aligned, apply medium pressure to the bottom center of the panel to secure it into place. Similarly apply pressure to the top center of the panel as well. You may also use the bottom of your fist to tap the panel back into place.

Note: The panels are secured once you hear and feel a *thump* securing the plastic clamp together with the base.

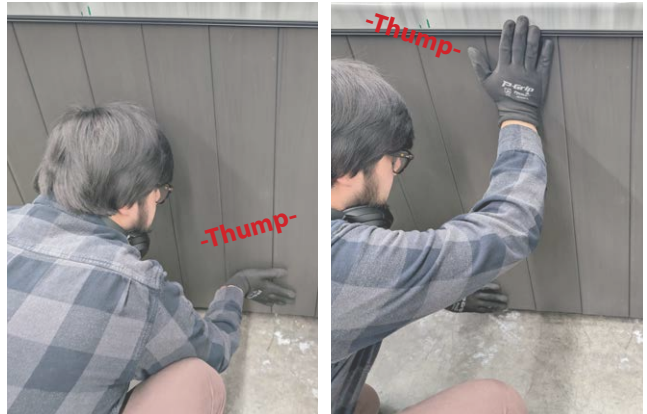

Step 7

Upon securing the front panel, proceed with installing the corners.

Similarly to how the corners were removed, align the corner with the lip of the spa, and ensure the top of the corner is under the black weather stripping of the spa shell. Reinstall the removed screws to secure the corner in place.



GFCI Wiring Diagram for USA & Canada

Control System	GFCI Require	Wires Required
IN.YE3 (2 Pump System)	40 Amp	Four #6 AWG Copper Wires
IN.YE5 (3 Pump System)	50 Amp	Four #6 AWG Copper Wires
IN.YE5 (4 Pump system)	60 Amp	Four #6 AWG Copper Wires

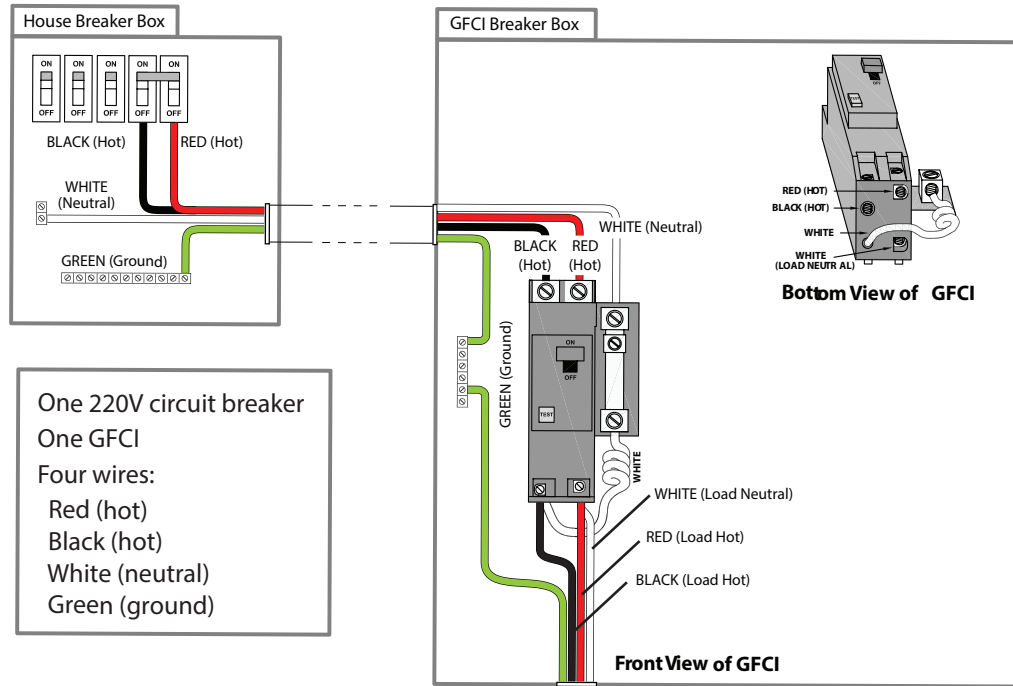

One 220V circuit breaker
 One GFCI
 Four wires:
 Red (hot)
 Black (hot)
 White (neutral)
 Green (ground)

Refer to this diagram for both:
 IN.YE-5-AMP-V3
 &
 IN.YE-3-AMP-V3

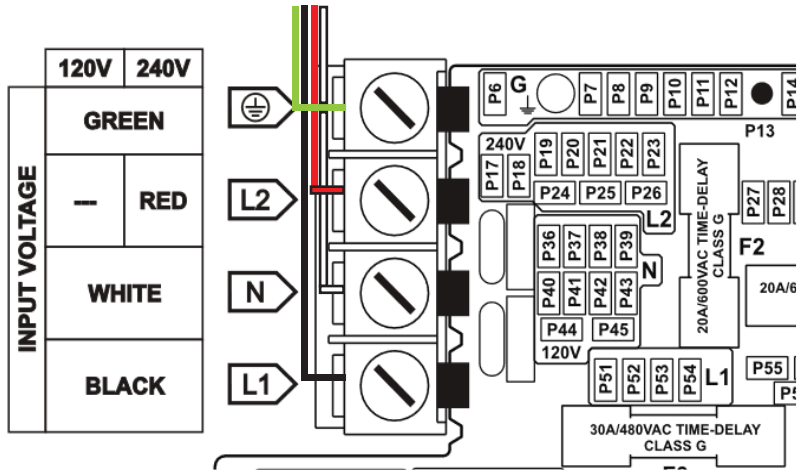

GFCI Breaker Testing

Test the GFCI breaker prior to first use and periodically when the spa is powered. To test the GFCI breaker.

1. Press the TEST button on the GFCI. The GFCI will trip and the spa will shut off
2. Reset the GFCI breaker by switching the breaker to the full OFF position, wait a moment, then turn the breaker on. The spa should have power again.

Step 1. Inspect the spa equipment.

Inspect all plumbing connections in the equipment area of your spa.

- Make sure unions in the equipment pack are tight. (Be careful not to over-tighten the plumbing fittings.)
- If your spa has gate valves, make sure they are all in the UP or OPEN position.
- Make sure the drain valve is closed and capped.

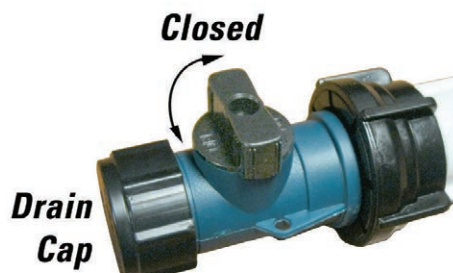
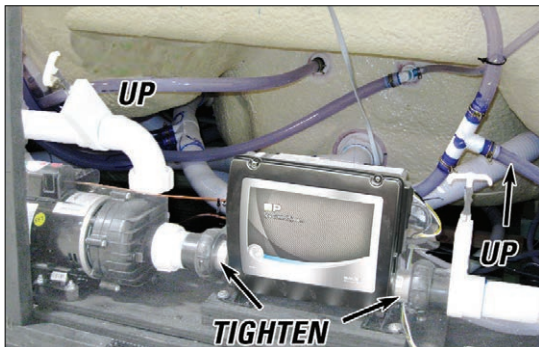

NOTE: Never run the spa with the gate valves closed or without water circulating for long periods of time.

Step 2. Remove the cartridge from the filter canister.

If the spa is equipped with a 75 sqft filter (color may vary), turn the skimmer component counterclockwise to unlock the skimmer. Pull the skimmer directly upward, after removal the retainer ring and basket are easily removed.

Note: Soak your filter cartridge for at least 30 minutes in water before reinstalling and using your spa for the first time. This removes air pockets inside of the filter cartridge.

Equipped on Escape X Spas & Platinum Spas

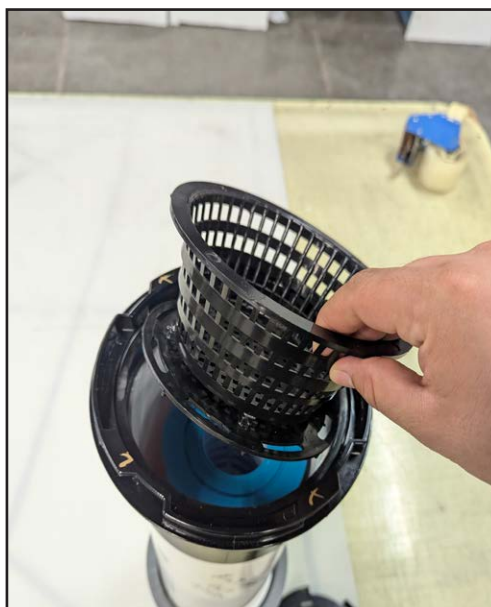

Note: Always fill the spa through the filter canister. This will help prevent air pockets from forming inside of the plumbing. Air pockets will prevent the primary pump from operating properly.

14 If the spa is equipped with a standard 50 sqft filter (black or gray), the skimmer is held in place with a locking ring during shipping. When preparing to fill your spa remember to remove the locking ring and remove the bobbing skimmer. Remove the filter by gently twisting the canister counter clockwise



Equipped on Deck Spas

Teleweir filter skimmer

- 50 square feet filtration
- Spoked cap

If you have a skimmer like this:

Rotate and remove the locking ring (Color may vary). Remove the skimmer cap and barrel, grip the filter by the handle and unscrew it from the canister. Replace and lock the locking ring and slid the skimmer cap and barrel back into the canister. Once the spa is filled you can remove the skimmer cap and barrel again to reinstall the filter.



The skimmer and barrel are locked in place during shipping with a retainer ring. The retainer ring must be unlocked and removed in order to slide the skimmer upward to remove the filter cartridge.



When removing the filter cartridge, you may remove the filter by turning it counter clockwise. The filter must be removed gently to not damage the threaded fitting inside of the filter canister.



After removing the filter, reinstall the retainer ring to the canister, then reinstall the skimmer, this skimmer must be able to move up and down with your water level. In the following step you will fill your spa with water through the filter canister.

NOTE: Never fill your spa with soft water.

Soft water makes it impossible to maintain the proper water chemistry and may cause the water to foam, which will ultimately harm the finish of the spa and void your warranty.

You may fill your fill your spa with well water provided the following conditions are met:

1. Purchase and use a pre-filter to run the well water on the fill-up. The pre-filter will be placed before the spa filter in the fill-up flow of water.
2. Have a Total Dissolved Solids (TDS) and metals test performed by a qualified person after the fill-up process but before any spa use

Step 3. Fill the Spa

Place the water hose inside the filter canister. Fill your spa with regular tap water about six inches from the top. If the water level is too low or too high, your spa will not operate correctly.

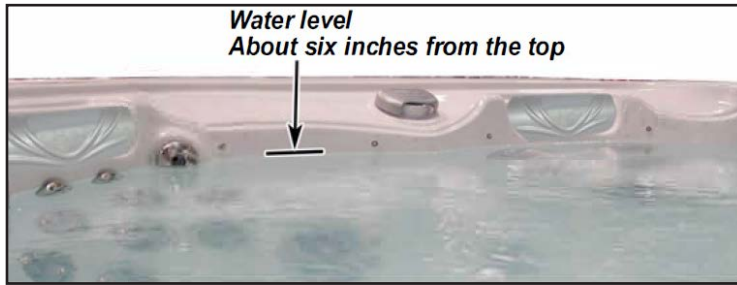

NOTE: Never fill with soft water.

Soft water made through some home filtration systems make it impossible to maintain proper water chemistry, and may cause water foaming. This can damage the finish of the spa and void your warranty.

You may fill your spa with well water, but only if the following preconditions are followed.

1. Purchase and use a pre-filter that can attach to the end of a hose. This pre-filter is absolutely necessary in order to remove reactive metals and other dissolved solids that are found in well water.
2. Perform a Total Dissolved Solids (TDS) and metals test, this can be performed by a qualified person after filling up the spa, before initial use. Most Dealers and pool supply stores can perform this test.

Step 4. Power Your Spa

When the spa is filled to the correct level, turn on the power at the GFCI breaker (ensure that the 120V spas are connected to their dedicated proper electrical outlet.)



Step 5. Prime the Main Pump

The system will enter priming mode when powered up for the first time. **Priming Mode** will scroll through the display on the control panel. In this mode all devices including pumps and lights are operable, you may press the jet buttons on and off to help prime the pumps. After a few minutes the system will exit priming mode.



16 Step 6. Install filter into the filter canister



Note: Make sure you have removed and soaked the spa filter cartridge in a bucket of water for at least 30 minutes. This will remove air pockets inside of the filter.

When re installing the filter cartridge, do not over tighten the filter, the threaded bit inside of the filter housing is made of a corrosion resistant ABS plastic. Excessive torque will break the internal threads within the filter housing.

Step 7. Test and Adjust Water Chemistry

Test and adjust the water chemistry.

Step 8. Let the Spa Heat Up

After a period of 5-15 minutes the priming mode will finish. The heater will then activate, put the spa cover on and let the spa heat to the desired set temperature.

During the initial power up the spa, it will consume a large amount of energy to raise the water in the tub to your desired hot tub temperature. Cal Spas are designed for high efficiency, once the temperature within the spa is reached, the spa will use lower amounts of energy to maintain the temperature.

Note: Cal Spas are designed to retain heat, if it is desired to lower the water temperature the spa does not contain a cooling feature. To lower internal temperature of the spa, lower the set temperature on the control panel and open the tub during the evening or night to help release the heat captured within. You may also drain 1/4 of the water within and refill with new water to lower temperatures rapidly.



New owners often have difficulty the first time they start their spa and the pumps fail to prime. This can be frustrating but these instructions should help you resolve any issues with air pockets inside of the primary pump or other priming issues.

Sometimes air can become trapped in the primary pump while filling up the spa, although this should be preventable by filling your spa through the filter basket, there is a chance that an air pocket can still form even when following the proper steps. Initially it may seem that the pump is not working, with some sound coming from the pump but no water movement.

Note: When a pump has an airlock, continuing to operate the pump experiencing an air pocket issue can damage the pump. Do not operate the pump until this airlock issue is fixed.

Start Up: Priming Mode

When the spa is powered up for the first time, the spa will enter priming mode. During this mode all devices within the spa is operational. You may wait for 10-15 minutes for the heater to engage, this period of time resets when a secondary pump is activated or if the primary pump is activated for high speed.

The spa will automatically exit priming mode.

Bleeding Air from the Pump

IF you have tried priming the pump by pressing the jet or jet 1 button on and off again with no results, you will need to bleed the pump manually.

1. Shut off power to the spa.
2. Using a philips head screwdriver, remove the front panel from the spa directly underneath the control panel, and locate the main pump.
3. Ensure that the gate valves are open
4. Place rags or towels under the plastic wet end of the pump where the spa plumbing connects into the pump
5. On the plastic wet end there will be a plastic hex headed bleeder valve that can be opened to bleed air trapped inside of the pump
6. Do not fully remove the nut, there are grooves within the nut that allows air to escape. Water will begin to trickle once the air pocket has been removed, tighten down the screw again with light torque.
7. If bleeding the pump is unsuccessful, loosen the pump unions with plumbing channel locks to remove any trapped air between the pump and the heater.
8. Turn the spa power back on and press the Jet button to prime the pump again.

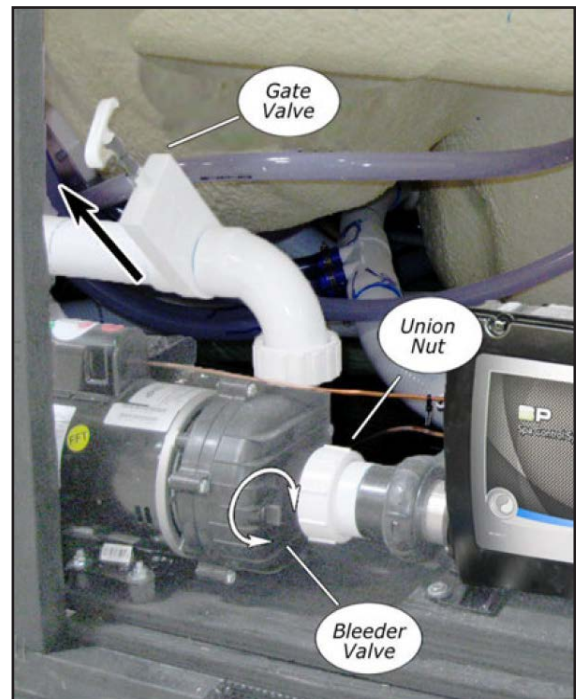

XL Heater Operation

Congratulations, your spa is equipped with the Cal Spas Lifetime XL Heater. The XL Heater is designed to last the expected lifetime of the spa. The heating element carries a unique 10 year warranty, at any point within 10 years of ownership if a defect were to arise, Cal Spas will offer a replacement heating element.

The XL Heater provides superior heating to bring your hot tub experience to the next level. When a spa is equipped with an XL Heater it brings the temperature of the spa water up much faster than traditional spa heaters, allowing more heat to dissipate or absorb into the water inside of the spas heater.

 **Warning: Dry Heater Risk. The XL heaters ability to dissipate heat quickly poses a risk is causing a dry fire. A dry fire can only occur in situations where the spa has been abused and not properly maintained. Before setting the temperature and using the spa, make sure that your filter is clean, and the is water movement from the primary pump .**

Operation Tips

The XL Heater functions like a traditional spa heater, but with the added benefit of faster heat absorption, and long life of heating components. When it comes to operating and caring for the heater, there are certain things spa owners must be mindful of while operating the spa. Most commonly spa owners will encounter some spa behaviors a spa owner would have not known about that is common with spas with larger than usual heating elements.

Air Gaps

Sometimes air can become trapped in the heater when turning on the spa, although this should be preventable by filling your spa through the filter basket, there is a chance that an air pocket can still form even when following the proper priming steps. This can cause the heater to overheat and display on the spa controller **“Message Code: 30, The heater is too hot”**. When this occurs,

1. Turn the power off to the spa from the GFCI breaker.
2. Remove the front cabinet panel (the panel directly under the spa controller) using a drill with a #2 Philips drill bit.
3. Once the panel is removed, bleed the primary pump connected to the control box using the bleeder valve (pg17)

Message Code 30

This specific message code can appear in the chance the spas power was interrupted during its heating phase or if there is a water flow restriction. The XL Heater will superheat the water inside of the heaters plumbing, if water flow is suddenly cut. In the situation this code does appear, turn off the spa from the GFCI for about 15-30 minutes to allow the heaters plumbing to cool. After 15-30min have passed, flip the GFCI back into the on position.

XL Heater Safety

Failure to properly bleed an air lock, or restriction within the spas heat plumbing before activating the spa heater, may lead to a dry fire. A dry fire is a fire that occurs when materials near the heating element such as the heaters insulation, the spa circuit board, and wires are super heated and spontaneously ignite. This can also occur when a spas filter is clogged or dirty, causing slow heat movement inside of the control box.

Proper care, filling, and start-up of your spa will eliminate this risk. Dry fires are not covered under warranty as this would fall under spa neglect, misuse, and abuse. Follow all procedures listed within your owners manual to avoid this risk.

This Page is Intentionally Blank.





Spa Touch Control System

Certain Cal Spa models are offered with an upgraded control panel, the Spa Touch 2 control system. The elegant 4 ½" touch display offers easy navigation of all of your spas equipment, with an elegant color LCD screen. The controllers main screen is designed display all main equipment options, including temperature control, LED light activation, and pump activation. There is easy access to your spas internal settings for filtration, time/date, heat modes, languages, and other specified features.

The top of the display is designed to offer insight on what operations or modes are activated inside of your spa. Ensuring that you know everything and anything your spa is doing at that very moment.

Display Care

To maintain and care for your spa display, we recommend using a microfiber towel to clean the display from finger prints. The touch screen is designed to respond to touch with wet hands, but excessive water droplets on the display should be wiped away with your hand before using the controller.

The Main Screen

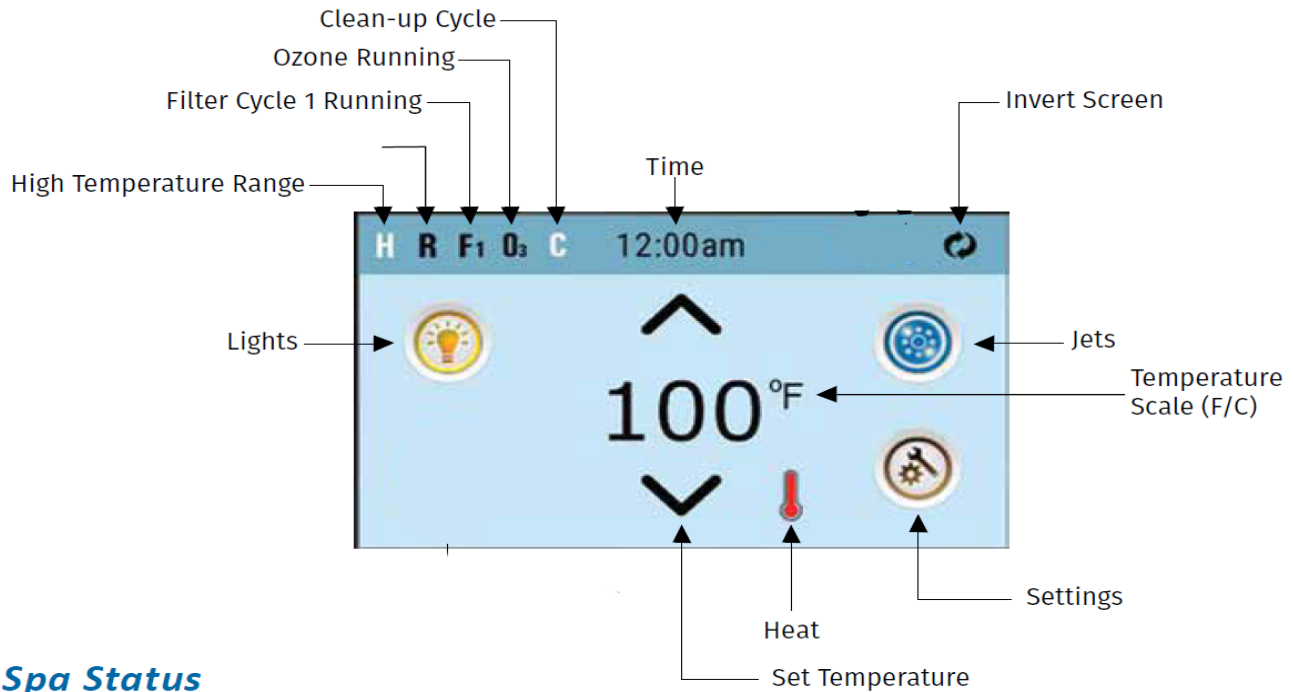

Spa Status

Important information can be found on the main screen, such as temperature adjustment, current spa operations, pump activation, lights, and the settings tab. Certain icons or options may not appear on your display, this dependent on the options your spa is equipped with.

- H = High Temperature Range
L = Low Temperature Range

 - R = Ready Mode | RR = Ready/Rest Mode
⌞ = Rest Mode

 - F1 = Filter Cycle 1 is running
● F2 = Filter Cycle 2 is running
● F+ = Filter Cycles 1 & 2 are both running

 - O₃ = Ozone is running. If you don't see the icon that means the Ozone is OFF.

 - C = Clean-up cycle is running.
Note: Not all systems that can run a Cleanup Cycle display this icon.

 - Wi-Fi icon just indicates that the Wi-Fi link is connected.

 - = Invert (or flip) Screen
- = Adjust set temperature higher

 - = Spa equipment control icon
Brings up a screen where the spa jets, blower or other equipment can be controlled. While on the Spa Equipment Screen, you can press a Jets button once for low speed, and if configured press it again for high speed.



 - = Jet is inactive. Indicates if a pump is running or not

 - Current water temperature if °F or °C is solid
Set temperature if °F or °C is flashing

 - = Settings is active = Settings is inactive
(when the panel is locked). Takes you to Settings Screen

 - Different animation sequences, including blinking, may indicate different stages of heating

● ∨ = Adjust set temperature lower

●  = on  = inactive  = disabled

●  = on  = inactive  = disabled

● Message waiting indicator: The Message Waiting Indicator will show one of the following icons:

 = fatal error (Spa can't function until it's fixed)

 = Normal Error or Warning

 = Reminder Message

 = Information Message

NAVIGATION



Music



Settings



Spa Equipment

MESSAGES



This icon indicates that a message is waiting for you to review, it can be an error code or a general message code.

After 30 seconds the display will enter sleep mode and power off, you can tap the display to wake up.

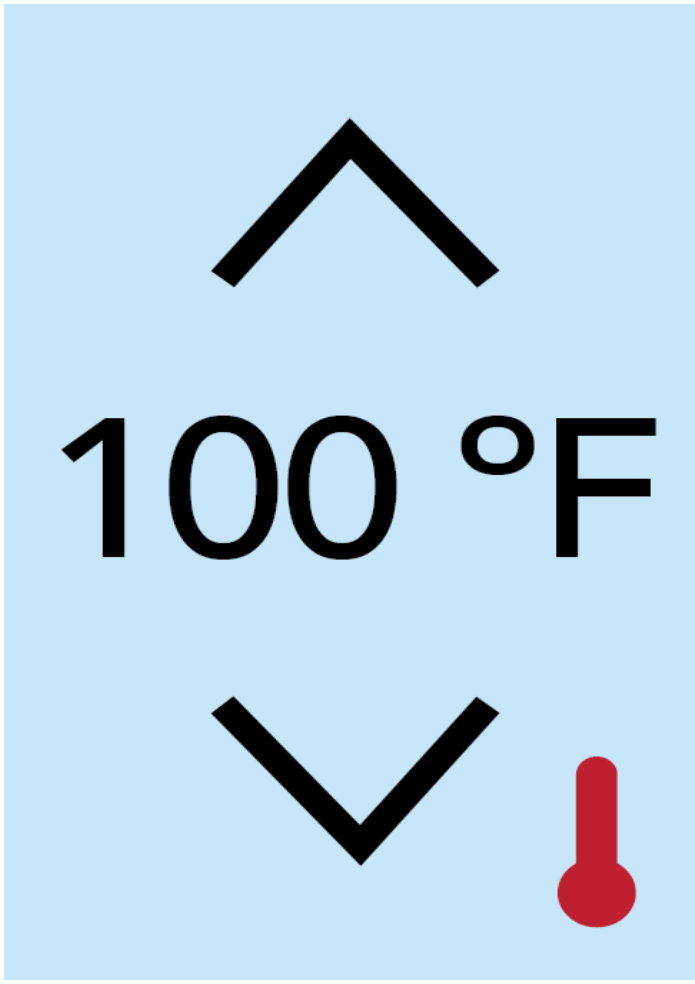



You can press the up and down arrows once to see what the spas set temperature is, this is shown by the temperature values changing in color to indicate the set temperature. Pressing the up or down arrows again will move the set temperature to whatever temperature you desire. You may also press and hold the arrows to change temperature.

Note: if the spas set temperature was 99°F, and you set the new temperature to a lower value for example 94°F, the spa will not chill and cool down. This change in value commands your spa heater to only activate to maintain 94°F. The heater will remain off until the water temperature falls below 94°F, in order to maintain the new set temperature.



Step 1. Touch the Settings Icon at the lower right portion of the screen.

 Appuyez sur l'icône Paramètres dans la partie inférieure droite de l'écran.

 Toque el icono de Configuración en la parte inferior derecha de la pantalla.

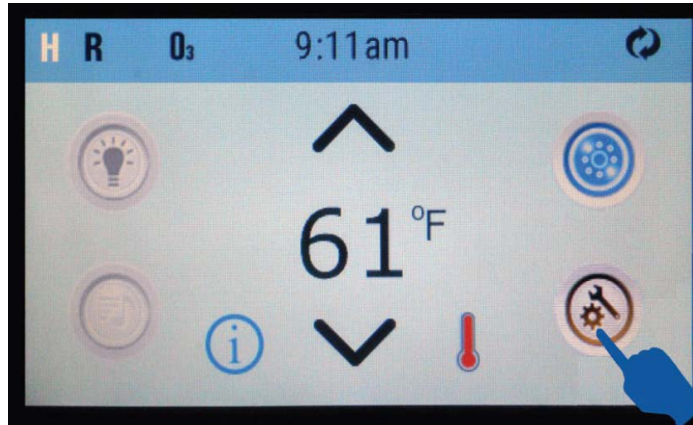

Step 2. Touch the right arrow icon at the lower right portion of the screen. Pressing this allows you to navigate to the next screen

 Appuyez sur l'icône de flèche droite dans la partie inférieure droite de l'écran. En appuyant dessus, vous pouvez accéder à l'écran suivant

 Toque el icono de flecha derecha en la parte inferior derecha de la pantalla. Al presionar esto, podrá navegar a la siguiente pantalla.

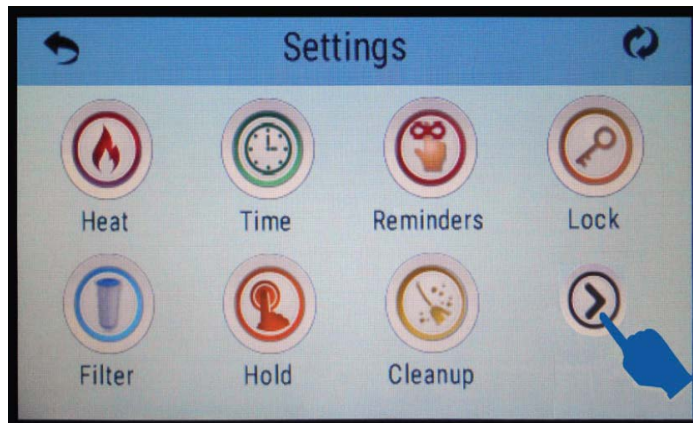

Step 3. Touch the Language icon

 Appuyez sur l'icône Langue

 Toca el icono de Idioma

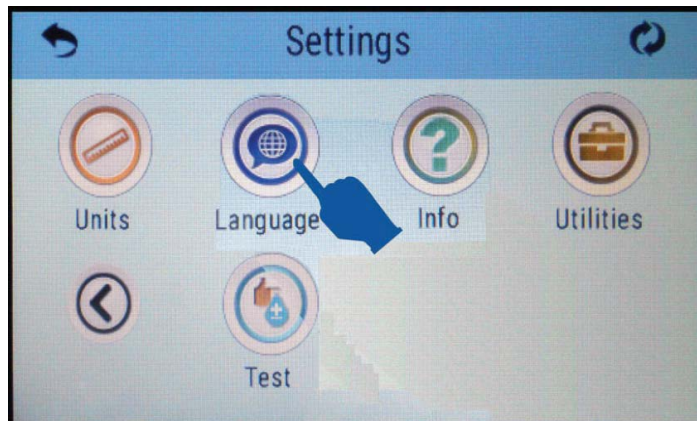



24 Once you select the language icon, the screen will open up a list of languages you can select, use the up and down arrows to navigate down the list of available languages.

 Une fois que vous avez sélectionné l'icône de langue, l'écran ouvrira une liste de langues que vous pouvez sélectionner, utilisez les flèches haut et bas pour parcourir la liste des langues disponibles.

 Una vez que seleccione el ícono de idioma, la pantalla abrirá una lista de idiomas que puede seleccionar, use las flechas hacia arriba y hacia abajo para navegar hacia abajo en la lista de idiomas disponibles

Step 4. Select your language of choice, we will select Spanish as an example.

 Sélectionnez la langue de votre choix, nous sélectionnerons l'espagnol comme exemple.

 Seleccione su idioma de preferencia, seleccionaremos español como ejemplo.

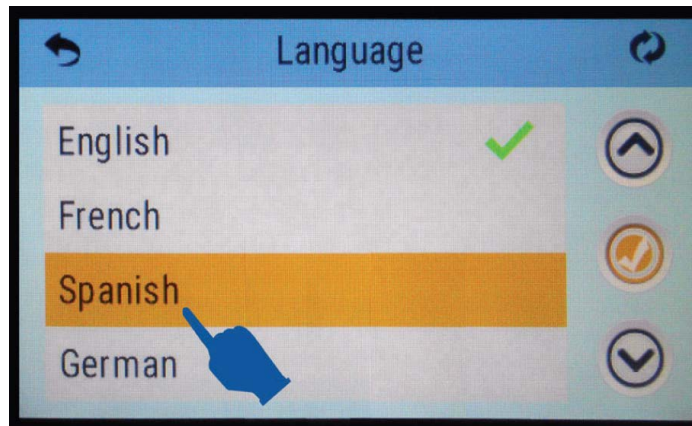

Step 5. The screen will refresh and your selected language of choice should now be the default setting.

 L'écran s'actualisera et la langue sélectionnée devrait maintenant être le paramètre par défaut.

 La pantalla se actualizará y el idioma seleccionado ahora debería ser la configuración predeterminada.

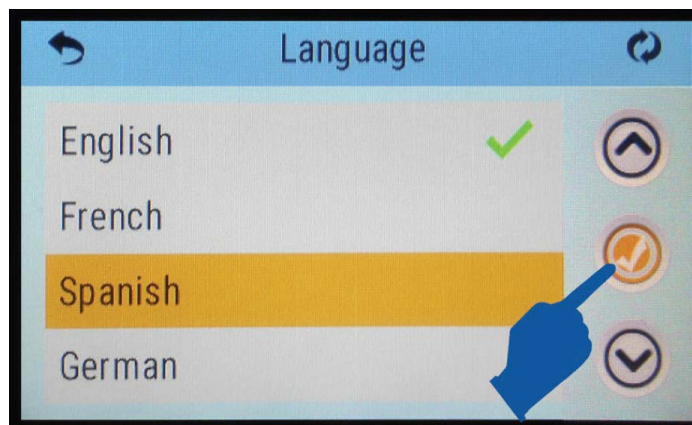

When your spa is first powered on the unit will enter a mode called priming mode, this also occurs whenever the power to the unit is cut off from a GFCI trip or a power surge. This modes purpose it to ensure the primary pump is clear of any air pockets or obstructions, and allows your temperature sensors to calibrate and read the water temperature to begin the heating process or to disengage the heater if the spa is already within its desired range.

When Priming Mode starts, the primary pump will turn on in low speed, then switch to high speed. This is done to purge any air pockets, that could have been trapped inside of the pump. This is considered normal operation. Priming mode will run for about 4-5 minutes, the spa will enter regular heating and filtering once Priming Mode ends. You can manually exit priming mode by pressing the "Back" icon on the priming mode screen.

Note: if after 2 minutes you see no water movement or hear the pump activating but no visible or notable water movement, cut the power to the spa from the GFCI and read the pump bleeding procedure in the beginning of this owners manual. A large air pocket within the pump could be causing issues with water circulation. Following the pump bleeding procedure, activate the spa power again. If there is no water movement within the spa, call your dealer for service as there could be an issue with your primary pump or control box.

Temperature Sensors

— — — — °F — — — — °C

When priming mode occurs, this allows time for the water temperature sensors inside of the control box to gather data and display the correct temperature. During priming mode or when you skip/exit priming mode, the sensors may show no values on its temperature reading. This is normal as it is collecting data through a period of time, to give an accurate reading. It usually takes about 1 minute of data collection for the display to properly display the temperature.

Freeze Protection

To prevent water freezing inside of the spa water lines and pumps, the sensors will detect drops in water temperature inside of the spa. The pump(s) will purge and run on max speed to circulate water inside of the spa to prevent the creation of ice. During cold/freezing weather it is recommended to keep the spa around 80F, filled up, and operating during the colder months. The insulation inside of the spa and the spa cover, will help retain heat inside of the spa. Although you can follow the winterization procedure inside of this manual, this does not guarantee against ice damage inside of the spa.

Pumps will run continuously or intermittently depending on the conditions and ambient temperature.

Ozonators

If your spa is equipped with an ozone generator, the ozone generator will operate during filtration cycles. Ozone generators help breakdown organic materials suspended inside of spa water, reducing odors and assists your sanitizers effectiveness.



Pump Speed Indicator



Fig. 1-01

The spa screen shows all available equipment to control based on your spa options. The icons shown in this screen may vary based on the number of pumps or additional options the spa is equipped/ordered with.

Some pumps have more than one speed, indicated by Figure 1-01, some spas have only one dual speed pump, and others can be equipped with one dual speed pump with additional single speed pumps.

If your spa was equipped with a circulation pump (24hr filtration system), the spa control screen will show if the circulation pump is active, but this pump will not be able to be controlled through the panel.

Navigation and Selection

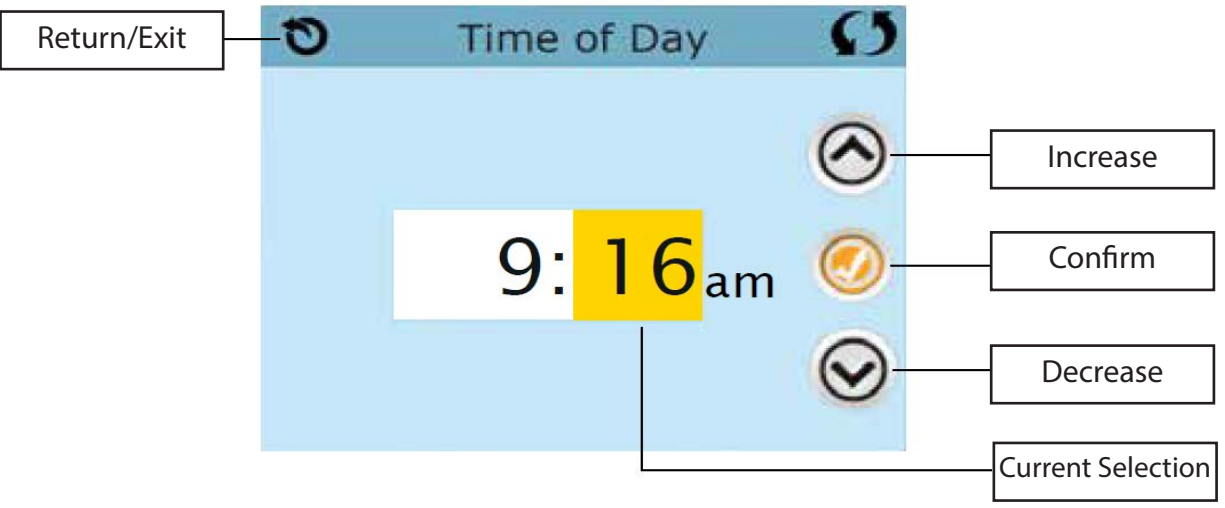

As you navigate through screens you can confirm what options are active or inactive by looking at the small check-mark icons within the selected page.



Active Save Button



Inactive Save Button



Page Left | Page Right : Certain menus contain more than one page to access all options. Use the navigation arrows as illustrated bellow to move page to page



Next Page

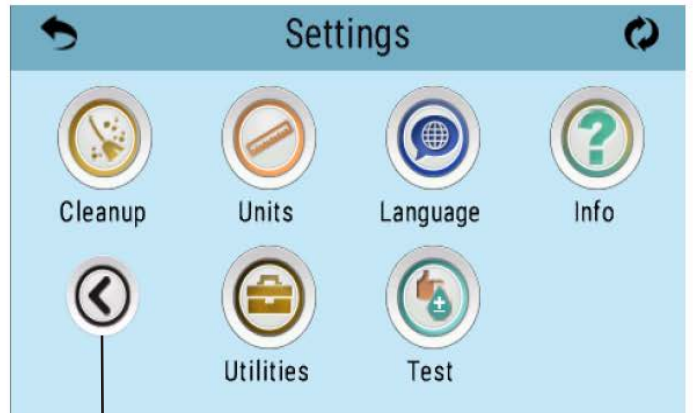

Previous Page

Similarly you will press these arrows to navigate up and down.

Depending on the screen these arrow icons can be used to change values or to navigate through the screen.

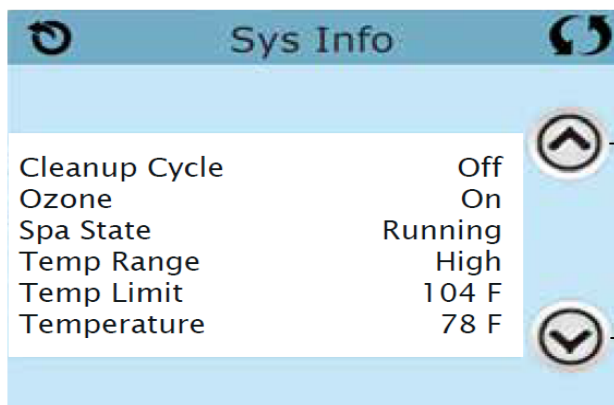

Line/Page Up

Line/Page Down

The Settings Screen

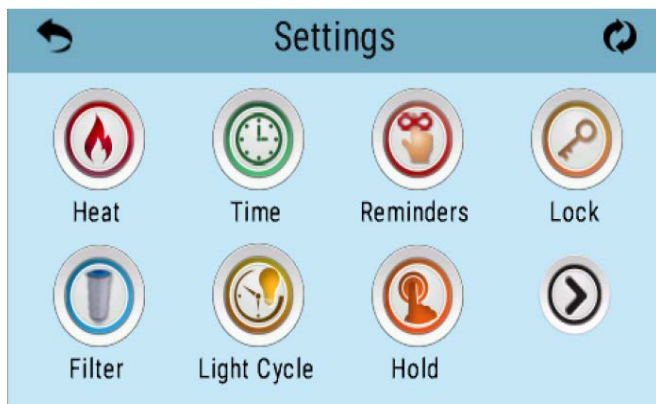

The settings screen is where all programming and certain spa operations are controlled. Each icon leads to a sub menu that can toggle specific parameters that fall under the mentioned option.



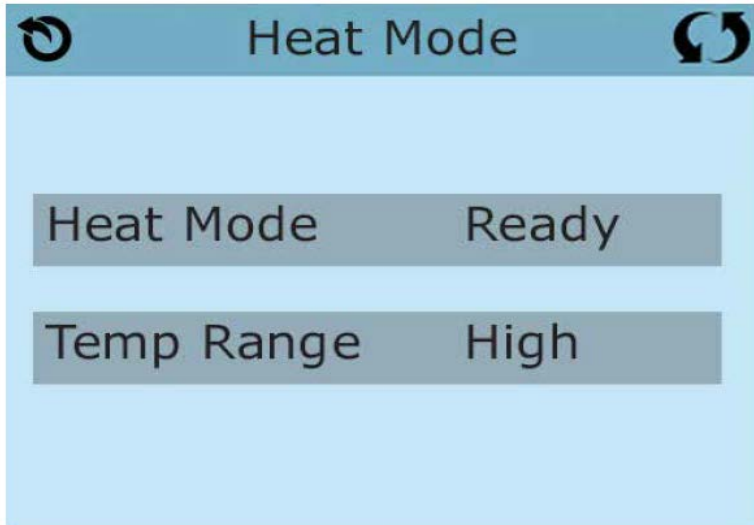

By pressing the 🔥 icon you will be able to access and control the heat range and heat mode of your spa.

Heat Modes:

Your spas heating system activates whenever the temperature falls below the set spa temperature, this is called "Ready" Mode.

To maximize energy efficiency and lower costs most spa owners will run high power demand operations such as filtration cycles in the evening or night, when energy costs are lower. You can also set the spas heater to only activate during its filtration cycle, this is called "Rest" Mode.

Ready in Rest Mode

In some spa models when the spa is programmed for rest mode and a jet button is pressed, the heater will kick on automatically. The heater will run for about 1 hour after a jet or pump is activated to maintain the heat of the spa while it is in use. Ideally its best to run a 3-4hr filter cycle at night when energy costs are lowest, allowing enough time for the spa to heat up during its filtration. This allows Ready in Rest mode to accommodate for small drops in temperature throughout the day.

Note: Always use your insulated spa cover to maintain the temperature within your spa.

Setting the Time of Day

It is important to set the time within your spa control system. Setting the proper time within your spa allows you to have better control of your filtration system and accurate reminder notifications. As long as the power to the spa remains active, the internal clock will display the correct time. Keep in mind that the spas control system does not account for daylight savings time, and will need to be manually adjusted.

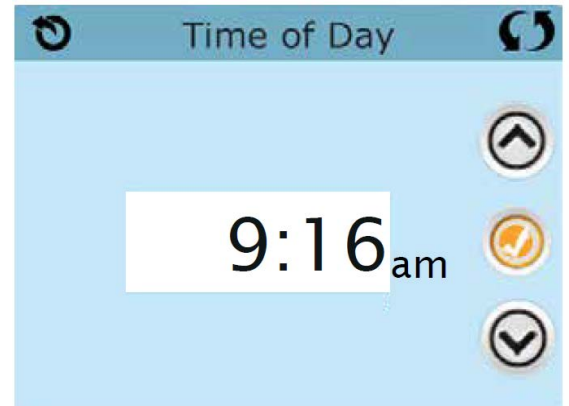

Message Code: 40

Whenever the power to your spa is interrupted or an electrical fault occurs, the internal clock will reset. This error also occurs when the spa is powered on for the first time.

Adjusting Filtration

Filter Cycles are very important in maintaining water clarity within your spa. Each setting can be adjusted by increments of 15 minutes. Most spa owners are able to maintain water clarity with a total of 3-4 hours of filtration per day. Your spa is able to have two separate filter cycle times based on your spa usage. By default filtration 1 is active, you can activate the second cycle by tapping the "2" icon and setting a time, confirmed with the checkmark on the right side of the screen. To maintain optimal filtration, make sure you perform regular maintenance on your filter cartridge. **Systems with a 24hr circ pump must set the start time from 12pm to 12am to activate the circ pump features.**

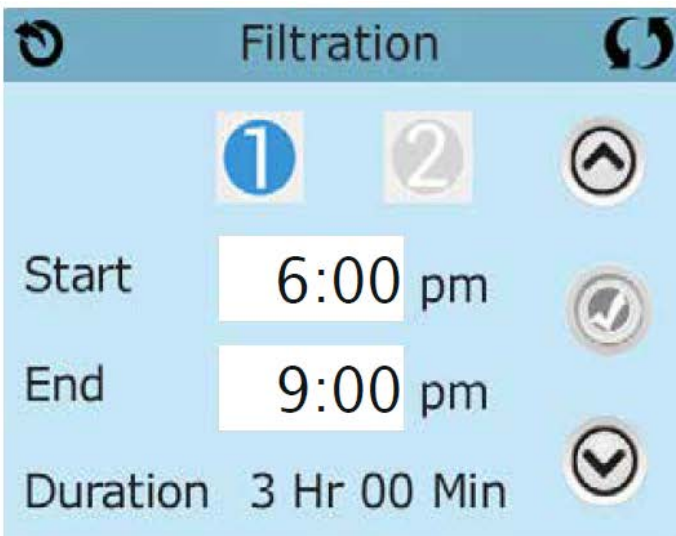
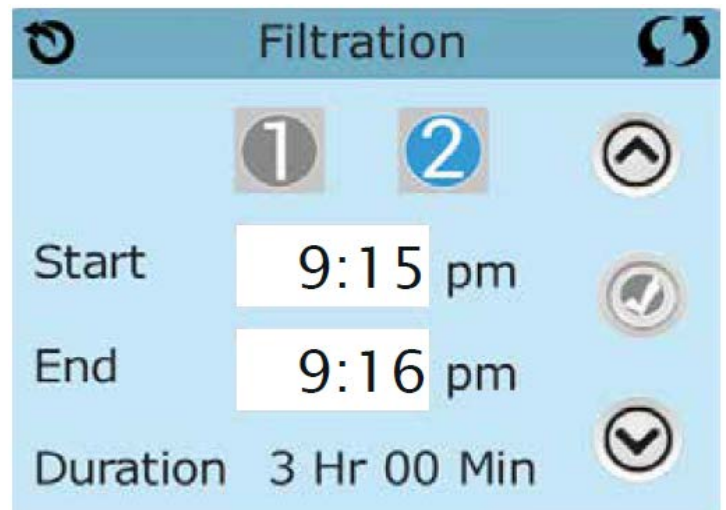

Viewing Filter 1 while Filter 2 is OFF:

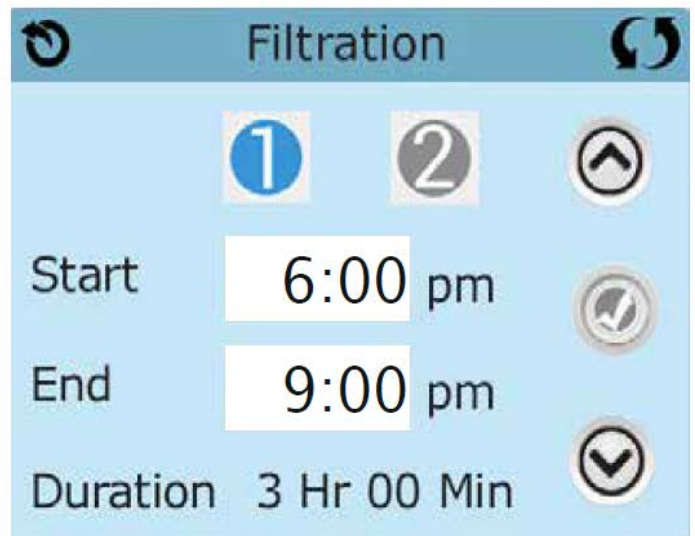

Viewing Filter 1 while Filter 2 is ON:

Panel Locking/Unlocking

You can restrict panel operation to prevent unwanted modifications to your spa settings, or spa operation. To lock either the panel or the settings select the settings tab, and press the "Lock" icon. The panel will show two icons, representing panel and settings. You may choose which kind of restrictions you want to activate. locking settings will restrict access to the spas settings, activating panel lock will restrict all spa panel operations. If you wish to unlock the display, place your finger on the top where the words "Lock" appear, hold your finger for about 5 seconds and the panel will unlock to its regular operations.

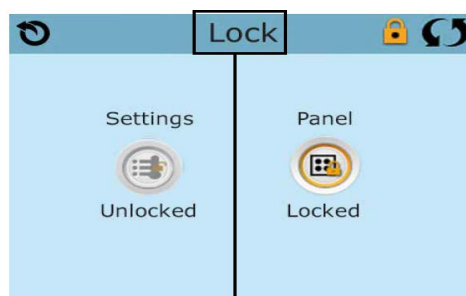

Press for 5 seconds

30 Utilities

The Utilities icon  on the settings screen will take you to the Utilities screen. This screen contains several options that can modify the operation of the touch panel, as well as testing tools and the spa fault logs.

Panel

Selecting the Panel icon allows you to choose the duration of time that the control panel remains activated before entering back into sleep mode. The display can remain active between an interval of 1 min to 60 min.

Demo Mode

Demo Mode is not always active, so it may not appear, this mode is designed to operate several spa features/devices in sequence. This mode is intended to showcase the various features of the spa.

Fault Log

The spas control system has an internal memory to keep track of any fault codes or messages that are generated. The fault log stores the last 24 error codes generated by the system. This includes normal operation codes and actual fault codes. For example "Priming Mode" will appear in the fault log but it is not a fault, it is a code that is used to keep track of when the spa restarts. Having codes like this appear in the fault log allows for better troubleshooting, by allowing technicians to see the spas entire code history to observe normal spa operations.

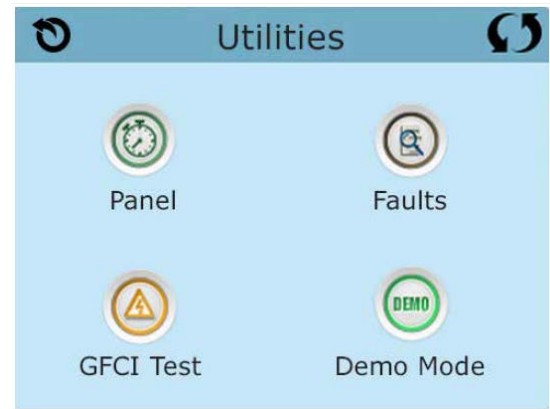

GFCI Test

This feature only exists with models sold in North America.

You are able to test the GFCI circuit connected to your spa through this feature to ensure that your GFCI is properly grounded and able to handle a surge or ground failure.

- Manual GFCI Test is enabled in this system
- GFCI test will not appear on your screen if its not enabled, with 120V systems this feature may not be enabled since there is a tested physical GFCI connected to 120V spas.

Additional Settings

Units

The units screen allows you to change the units of the display from either imperial inches or Metric

Reminders

The reminders Icon takes you to the reminders screen. Choosing to have reminders activated will allow you to get maintenance reminders on the display of your spa. This can range from reminders to perform filter maintenance or to remind you to change the spa water if needed. These reminders are based off of common water intervals, some reminders may recommend a task that may not be necessary based on your spa usage.

Note: The only way to properly maintain your spa is by regular maintenance and spa water testing.

Clean Up Cycle

Your spa will start a clean up cycle every time after you activate the pump or spa lights. The duration of the clean up cycle can be changed based on your spa usage. For example the spa normally performs a 30 minute clean up cycle after use, if you tend to use this spa with a heavy bather load (more than 2 people), it would be a good idea to increase the amount of time the clean up cycle operates for.

You may also disable this feature by setting the time to 0.0



General Messages & Heater-Related Messages

Water is too hot - M029

The system has detected water temp of 110°F (43.3°C) or more, spa functions are disabled. The system will auto reset when the spa water temp is below 108°F (42.2°C). Check for extended pump operation or high ambient temp.

Water flow is low - M016

There may not be enough water flow through the heater to carry the heat away from the heating element. Heater will attempt to start up again after 1 minute. Correct any water flow restrictions.

Water flow has failed - M017

There is not enough water flow through the heater to carry the heat away from the heating element and the heater has been disabled. After the problem has been resolved, reset the message.

The heater may be dry - M028

Possible dry heater, or not enough water in the heater to start it. Shut down the spa for 15 min to reset this message. Call for service if this message does not clear, as there could be an issue with your sensors or your spa pumps.

The heater is dry - M027

There is not enough water in the heater to start it. The spa is shut down. After the problem has been resolved, you must reset the message* to restart heater start up.

The heater is too hot - M030

This code occurs when, one of the water temp sensors has detected 118°F (47.8°C) in the heater. When this happens the spas current operations will shut down. You must reset the message, and this message will not reappear, when the water in the heater is below 108°F (42.2°C).

Sensor-Related Messages

Sensors are out of sync - M015

When this error code appears, the temperature sensors may be out of sync by 3°F. Call your dealer for service, if this message does not disappear within a few minutes.

Sensors are out of sync - M026

This code is specific to when the system has detected a consistent temperature difference between the sensors of 3°F or more. Contact your spa dealer for service.

Sensor A/B Fault - M031/M032

Either temperature sensor A, B, or both have failed due to a circuit failure. Call your spa dealer for service.

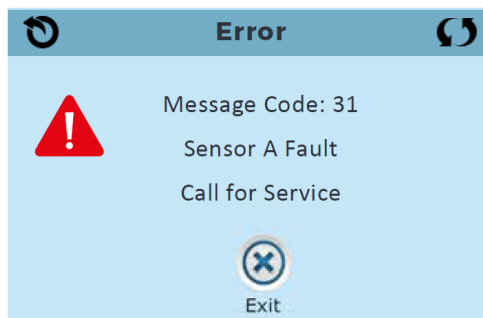

Sensor-Related Messages

Communications Error

The control panel is not receiving communications from the control system, call your spa dealer for service.

Test software installed

33

The control system is operating with test software. Contact your spa dealer for service or to reformat the unit.

System-Related Messages

Settings have been reset - M021

Contact of spa dealer if this message appears on more than one power up. This could be an internal memory issue.

The clock has failed - M020

The internal clock in your control system has failed. Contact your spa dealer for service.

GFCI Test has failed - M036

Indicates the failure of an automated GFCI self test. This highlights a possible issue with your spas GFCI electrical circuit.

A pump may be stuck on M034

Indicates the failure of an automated GFCI self test. This highlights a possible issue with your spas GFCI electrical circuit.

Hot fault - M035

A pump is possibly in a stuck on position when the spa was last powered on. Meaning the electrical switch controlling the pump is stuck in the on position, ignoring the switch off command. DO NOT ENTER THE SPA, DO NOT ENTER THE WATER. Contact your spa dealer for service.

Reminder Messages

Check the PH

May appear on a regular schedule, i.e. every 7 days. Check pH with a test kit and adjust pH with the appropriate chemicals.

Check the sanitizer

May appear on a regular schedule, i.e. every 7 days. Check sanitizer level and other water chemistry with a test kit and adjust with the appropriate chemicals.

Clean the filter

May appear on a regular schedule every 30 days. Rinse the filter cartridge out and gently reinstall.

Test the GFCI

May appear every 30 days. The GFCI is an important safety device that should be tested to verify its reliability.

Change the water

May appear every 90 days. A general recommendation of draining the spa and using new water to ensure water clarity and proper sanitation. This interval is dependent on spa usage and bather load, this interval might be shorter or longer. Spas with heavy usage may require a water change every 30-60 days, and spas with minimal usage may require a water change every 90-120 days.

Clean the cover

May appear every 180 days. This reminder is to remind you to clean your vinyl spa cover, and treat the vinyl cover with a spa UV protectant. This will ensure maximum life of your spa cover.

Change the UV

May appear on a regular schedule. The UV light may need to be changed, contact your spa dealer for service.

Change the filter

May appear on a regular schedule every 365 days. Filters when properly maintained should be changed out every 365 days to maintain proper sanitation.

Check ozone

May appear on a regular schedule. If your spa is equipped with an ozone system, it is recommended to inspect the ozone generator once a year for proper operation.

Service check - up

May appear on a regular schedule. **This does not indicate that the spa is encountering a problem.** This is just a reminder to inspect the operation of your spa and to contact your spa dealer or the manufacture if anything is not operating as designed.





THE MAIN SCREEN

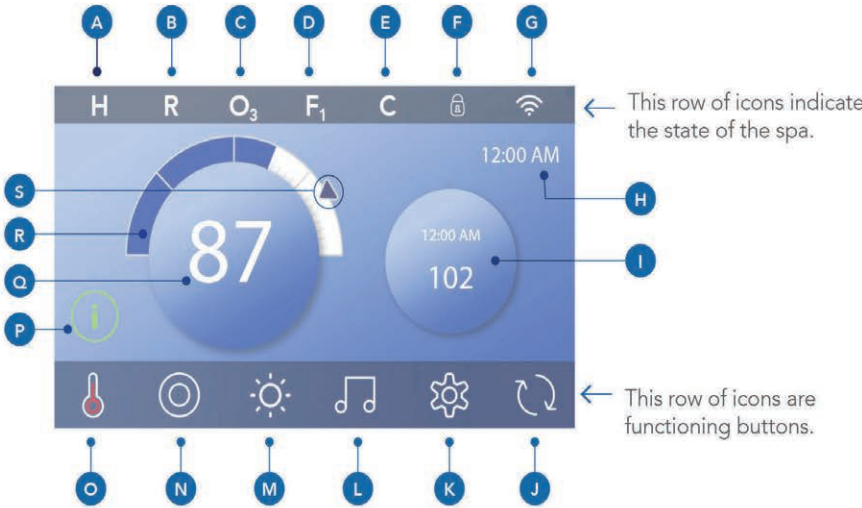

← This row of icons indicate the state of the spa.

← This row of icons are functioning buttons.

Main Screen Icons

- A** - Temperature Range
High: **H**
Low: **L**
- B** - Heat Mode
Ready: **R**
Rest: **☒**
Ready-in-Rest: **RR**
- C** - Ozone Running: **O₃**
- D** - Filter Cycles
Filter Cycle 1: **F₁**
Filter Cycle 2: **F₂** (Optional Feature)
Filter Cycles 1 & 2: **F+**
- E** - Cleanup Cycle (Optional Feature)
- F** - Panel Locked and/or Settings Locked
- G** - WiFi (Local or Cloud Connection)
- H** - Time-of-Day
- I** - Secondary Button/Display
- J** - Invert Display
- K** - Settings
- L** - bba™ versions 2 and 3 (Balboa Bluetooth Audio)
- M** - Light (or CHROMAZONE™ if installed)
Both icons change from white to color when these devices are powered On.
- N** - Spa
- O** - Heater Status
- P** - Message Button (May Appear)
Information: ⓘ
Reminder: Ⓜ
Error - Normal Error or Warning: ⚠
Error - Spa will not function until fixed: ⚠
- Q** - Water Temperature
- R** - Water Temperature Bar
- S** - Set Temperature Arrow

The system configuration determines the number of icons that appear on the Main Screen. Your Main Screen may have fewer or different icons.



Spa Status



Important information about spa operations can be seen on the Main Screen. Most features, including Set Temperature adjustment, can be accessed from this screen. The actual water temperature can be seen, and the Set Temperature can be adjusted

Time-of-Day, Ozone and Filter status are available, along with other messages and alerts. The selected Temperature Range is indicated in the upper left corner. A Lock icon  is visible if the Panel and/or Settings are locked. Near the bottom of the screen, at certain times an indicator may appear showing that a message is waiting. Touch this indicator to go to the Message Display Screen. On that Screen some of the messages can be dismissed.

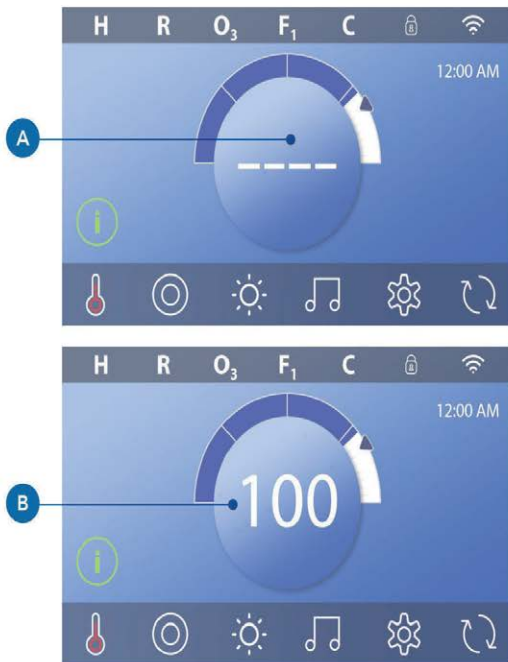

When the spa is powered On, four dashes appear (A) in the Water Temperature display for one minute. The dashes indicate that the spa is checking the water temperature. After the pump runs for 1 minute, the dashes disappear and the water temperature is displayed (B). The dashes may reappear after the pump has not run for one hour.



SET THE TIME-OF-DAY

Be sure to set the Time-of-Day

- Follow this sequence to set the time-of-day.
- In the Main screen, press the Settings button (B).
 - In the Settings screen, press the Time button (C).
 - In the Time of Day screen, press the Time button (D).
 - Setting dials appear. Swipe these dials (F) to set the time. If your desired time value appears but is not aligned with the arrow, tap the desired time value to make it align with the arrow.
 - Press the Save button (G) to save your settings. Or, press the Cancel button (E) to cancel your settings.

Setting the time-of-day is important for determining filtration times and other background features. If Time-of-Day needs to be set, the Information Message button (A) appears on the Main screen; view the previous page for more information on the different types of Message buttons.

NOTE: If power is interrupted to the system, Time-of-Day will be maintained for several days (this only applies to some systems).

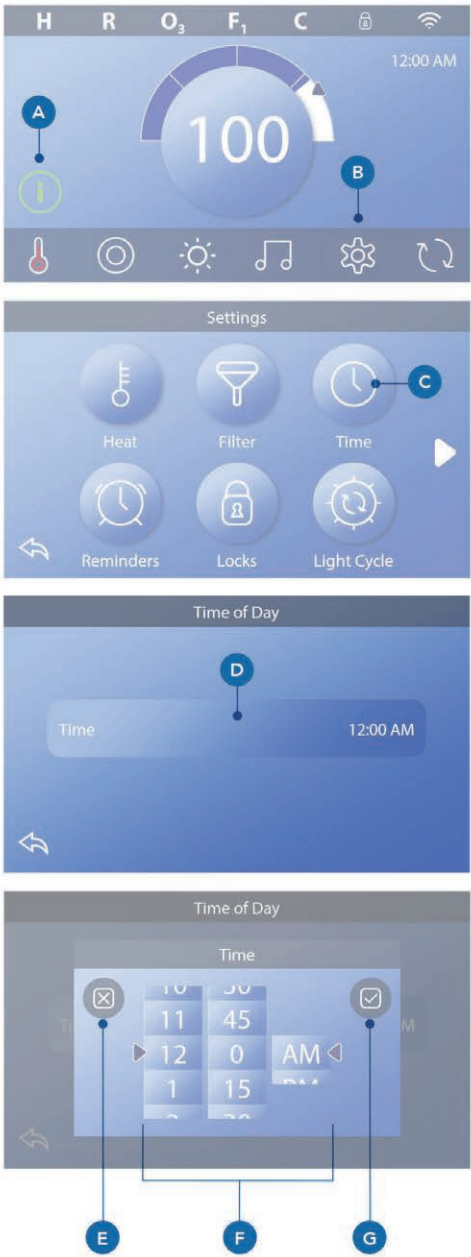

SET THE TEMPERATURE

In this example we will set the Set Temperature to 102.

- Press the water temperature display button (A) to make the temperature menu appear (B). The center box with the arrow (C) indicates the current Set Temperature.
- If 102 is already showing, but just not centered (D), touch it to center it (E).
- If 102 is not showing (B), swipe the temperature menu until 102 appears (D).
- If 102 appears after swiping but does not stop in the center box (D), press 102. Pressing 102 makes it shift to the center box (E).
- Press the water temperature display (A) to make the temperature menu disappear. The Set Temperature is now 102.

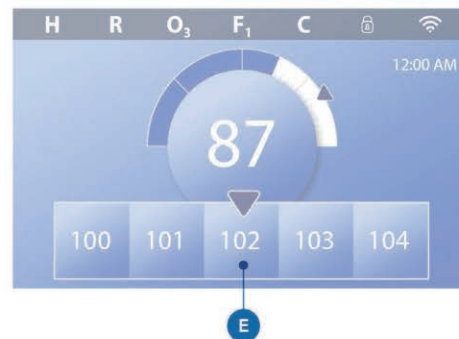
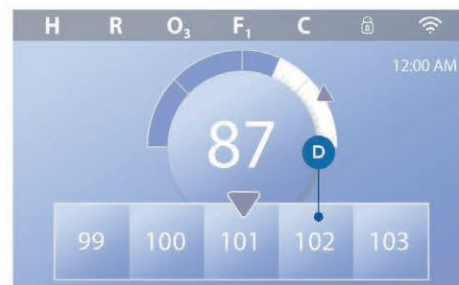
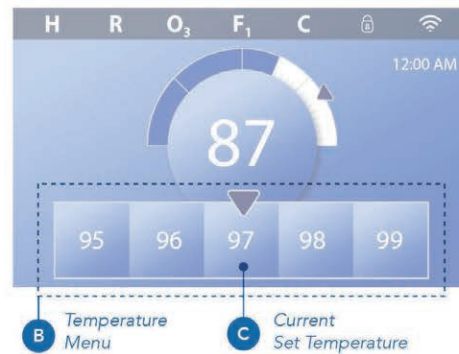
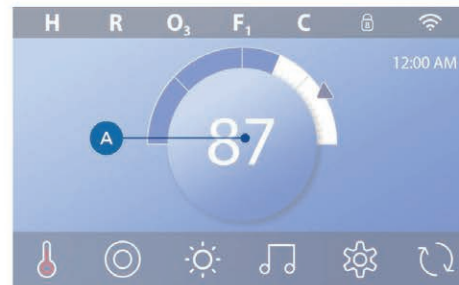

Heater Off





Heater On

Note: the Heater Status button icon flashes during heater start-up; this is normal.



RUN SPA DEVICES

Press the Spa button  (A) to view the Spa screen. Press these buttons (B) to run spa devices. Some devices may only turn On and Off, while other devices may have multiple speeds/states. Your spa configuration determines the number of buttons and the function of the buttons in the Spa screen. One Spa screen displays six buttons, maximum. If more than six buttons exists, a navigation button appears (D). Press the navigation button (D), or swipe, to view the next Spa screen. Press the Back button  (C) to navigate to the Main screen.

If the Jets are left running, they will turn off after a time-out period.

If the Spa has a circulation pump, a circulation pump icon will appear in the Spa screen to indicate its activity only (the icon is not a functioning button). The circulation pump can be controlled with a button during Priming mode

If the spa does not have a circulation pump, then Jets 1 may turn On automatically at times. In these cases, pressing the Jets 1 button will just change speeds, but will not turn Off Jets 1.

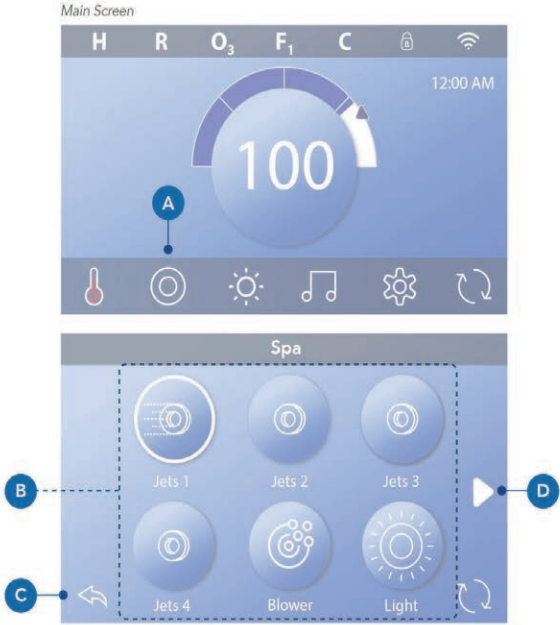

SET FILTER CYCLE TIME

Keep your water clean and ready to enjoy

Follow these steps to set the time for Filter Cycle 1.

- Press the Settings button (A) on the Main screen.
- Press the Filter button (B) on the Settings screen.
- Press the Start button (E) on the Filter Cycles screen.
- Set the Start Time with these dials (J) on the F1 End screen.
- Press the Save button (K) to save your settings, or press the Cancel button (I) to cancel your settings.
- Press the End button (F) on the Filter Cycles screen, and follow the same steps to set the End Time.
- Once the Start and End Times are set, press the Save button (G) on the Filter Cycles screen.
- Once Start and End Times are set, the Duration appears here (H). You have now set the time for Filter Cycle 1. The white ring (C) indicates that Filter Cycle 1 is enabled (it is always enabled).

Follow the same steps noted above to set the time for Filter Cycle 2.

How can you tell if Filter Cycle 2 is enabled?

Filter Cycle 2 is enabled when a white ring appears around the ② button. For example, Filter Cycle 1 is enabled (C) in this screen, and Filter Cycle 2 is disabled (D). Press the ② button to enable/disable Filter Cycle 2. A Filter Cycle 2 will only run if it is enabled.



Note: It is possible to overlap Filter Cycle 1 and Filter Cycle 2, which will shorten overall filtration by the overlap amount.



RESTRICT OPERATIONS

The following examples show how to lock and unlock the Panel.

LOCK PANEL

- Press the Settings button  (A) on the Main screen.
- Press the Locks button  (B) on the Settings screen.
- Press the Panel button (C) on the Locks screen. "Lock Panel" will appear at the top of the screen (D).
- Press-&-hold "Lock Panel" (D) for five seconds. After five seconds a Lock icon  (E) will appear in the top row. The lock icon also appears in the top row of the Main screen. The panel is now locked.

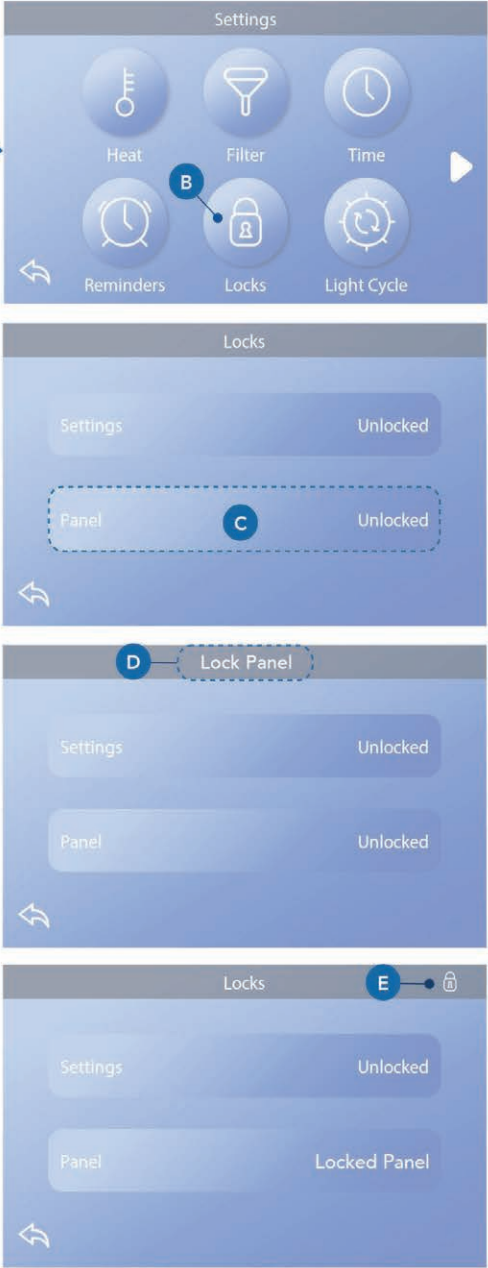
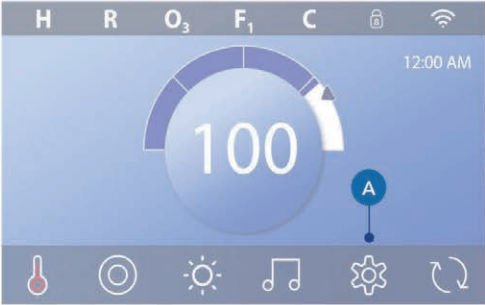

(Continued on next page)

UNLOCK PANEL

- Press the Panel button (F) in the Locks screen, and "Unlock Panel" will appear at the top of the screen (G).
- Press-&-hold "Unlock Panel" (G) for five seconds. After five seconds the Lock icon (A) will disappear from the top row (I) of the Locks screen. The panel is now Unlocked.

The control can be restricted to prevent unwanted use or temperature adjustments. Locking the Panel prevents the controller from being used, but all automatic functions are still active.

LOCK & UNLOCK SETTINGS

Follow the same steps noted above to lock and unlock Settings.

Locking the Settings allows Jets and other features to be used, but the Set Temperature and other programmed settings cannot be adjusted. Settings Lock allows access to a reduced selection of menu items. These include Filter Cycles (view only), Invert, Information and Fault Log. They can be seen, but not changed or edited.

Can Settings and Panel be locked simultaneously?

Yes. The lock icon (K) appears if Settings or Panel or both are locked. The current lock states are noted on the right side of the buttons (H).

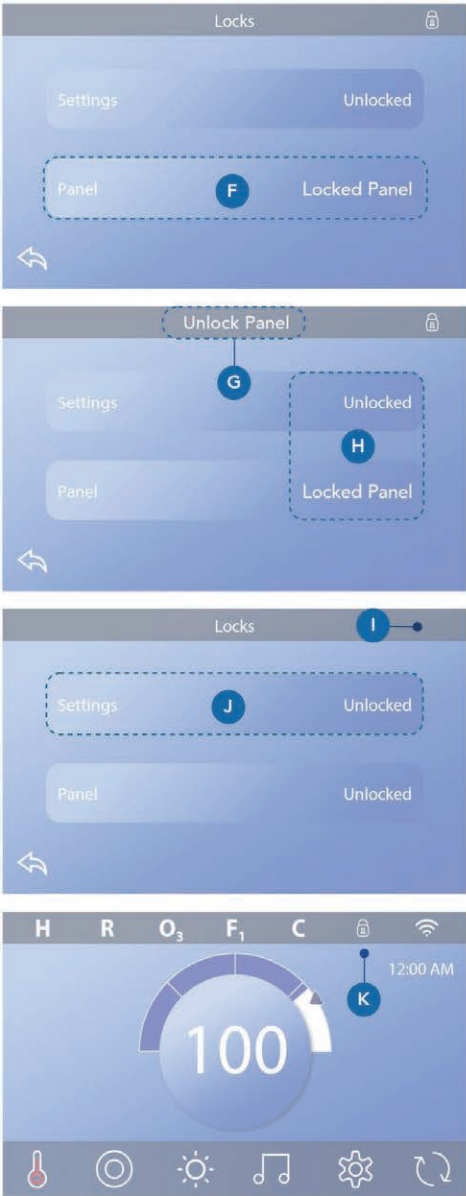

Circulation Pump Modes

If the system is equipped with a circulation pump, it will be configured to work in one of three different ways:

1. The circulation pump operates continuously (24 hours) with the exception of turning off for 30 minutes at a time when the water temperature reaches 3°F (1.5°C) above the set temperature (most likely to happen in very hot climates).
2. The circulation pump stays on continuously, regardless of water temperature.
3. A programmable circulation pump will come on when the system is checking temperature (polling), during filter cycles, during freeze conditions, or when another pump is on.

The specific Circulation Mode that is used has been determined by the Manufacturer and cannot be changed in the field.

Filtration and Ozone

If a spa does not have a circulation pump, Pump 1 low and the ozone generator will run during filtration. On circ systems, the ozone will generally run with the circulation pump, but can be limited to filtration cycles. (On some circ systems, Pump 1 low will run along with the circulation pump during filtration.)

Most systems are factory-programmed with one filter cycle that will run in the evening (assuming the time-of-day is properly set) when energy rates are often lower. The filter time and duration are programmable. A second filter cycle can be enabled as needed. At the start of each filter cycle, the water devices like blower, mister device (if these exist) and other pumps will run briefly to purge the plumbing to maintain good water quality.

Freeze Protection

If the temperature sensors within the heater detect a low enough temperature, then the water devices automatically activate to provide freeze protection. The water devices will run either continuously or periodically depending on conditions. In colder climates, an optional freeze sensor may be added to protect against freeze conditions that may not be sensed by the standard sensors. Auxiliary freeze sensor protection acts similarly except with the temperature thresholds determined by the switch. See your dealer for details.



Clean-up Cycle (optional)

When a pump or blower is turned on by a button press, a clean-up cycle begins 30 minutes after the pump or blower is turned off or times out. The pump and the ozone generator will run for 30 minutes or more, depending on the system. On some systems, you can change this setting.

Clean-up cycles allow the spa to filter less when the spa is used less often, and to filter more when the spa is used more often.

DIAGNOSTICS SCREEN

The Diagnostics screen is helpful for spa technicians.

Here is how to navigate to the Diagnostics screen starting from the Main screen. Pressing the Settings button  and then the Diagnostics button .

Info

Info (A) displays various settings and identifications of this system.

System Model

Displays the Model Number of the System.

Panel Version

Displays a number of the software in the topside control panel(D).

Software ID (SSID)

Displays the software ID number for the System.

Configuration Signature

Displays the checksum for the system configuration file.

Current Setup

Displays the currently selected Configuration Setup Number.

Dip Switch Settings

Displays a number that represents the DIP switch positions of S1 on the main circuit board.

Heater Type

Displays a heater type ID number, or "Standard".

Heater Voltage (North American system / UL)

North American/UL control systems display operating voltage configured for the heater.

Heater Wattage (International System / CE)

International/CE control systems display the heater wattage range that is configured for the control system.

Faults

Faults (B) is a record of the last 24 faults that can be reviewed by a service tech. Use the arrow buttons to view each entry in the Fault Log. When Priming Mode shows in the Fault Log, it is not a fault. Rather, it is used to keep track of spa restarts.

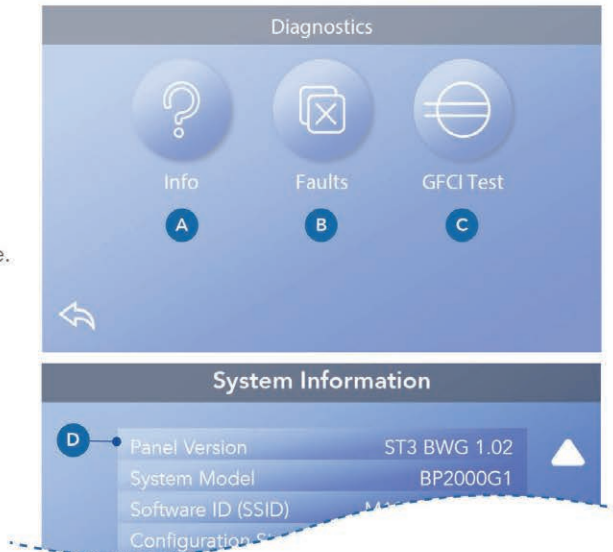

HEAT SETTINGS

Ready to enjoy!

Make sure your spa is heated and ready to enjoy with Heat Settings. Navigate to the Heat Settings screen from the Main screen by pressing the Settings button . Press the Heat button , and the Heat Settings screen appears (A). The Heat Setting screen does not have Save or Cancel buttons, so changes you make take effect immediately.

Heat Mode (B)

Ready **R**

Ready Mode (B) keeps the water temperature within 1° F (0.5° C) of the Set temperature. For example, if the set temperature is 102° F (39.0° C), the water temperature will be within +/- 1° F (0.5° C) of 102° (39.0° C). Press the Heat Mode button (B) to switch between Ready and Rest Mode. The **R** icon appears on the Main screen when the spa is in Ready Mode.

Rest

Rest Mode functions the same as Ready Mode, except Rest Mode only heats the water during filter cycles

Press the Heat Mode button (B) to switch between Ready and Rest Mode. The icon appears on the Main screen when the spa is in Rest Mode.

Ready-in-Rest **RR**

Ready-in-Rest Mode is the same as Rest Mode, except Ready-in-Rest Mode heats the water, if necessary, for one hour when you turn On Jets 1. The **RR** icon

appears on the Main screen when the spa is in Rest-in-Rest Mode.

If the spa is in Ready-in-Rest mode and you go to the Heat Settings screen (A), that cancels Ready-in-Rest Mode and puts you back into Rest Mode, even if you press no buttons while on the Heat Settings screen.

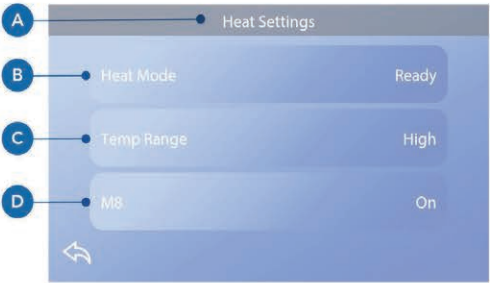

Heater Pump

In order for the spa to heat, a pump needs to circulate water through the heater. The pump that performs this function is known as the "heater pump".

The heater pump can be either a 2-speed pump (Pump 1) or a circulation pump. If the heater pump is a 2-Speed Pump 1, Ready Mode will circulate water at various intervals, using Pump 1 Low, in order to maintain a constant water temperature, heat as needed, and refresh the temperature display. This is known as "polling."

Rest Mode will only allow heating during programmed filter cycles. Since polling does not occur, the temperature display may not show a current temperature until the heater pump has been running for a minute or two. When the heater pump has come on automatically (for example for heating) you can switch between low speed and high speed but you cannot turn the heater pump off.



Temp Range (C)

There are two Temp Range settings: High and Low.

High H

The water temperature can be set between 80° - 104° F (26.6° - 40.0 C) when Temp Range is set to High. Press the Temp Range button (C) to switch between High and Low Range. The **H** icon appears in the top row of the Main screen when the spa is in High Range.

Low L

The water temperature can be set between 50° - 99° F (10.0° - 37.2° C) when Temp Range is set to Low. Press the Temp Range button (C) to switch between High and Low Range. The **L** icon appears in the top row of the Main screen when the spa is in Low Range.

Different High and Low Temp Ranges may be determined by the Manufacturer.

Freeze Protection is active in High and Low range.

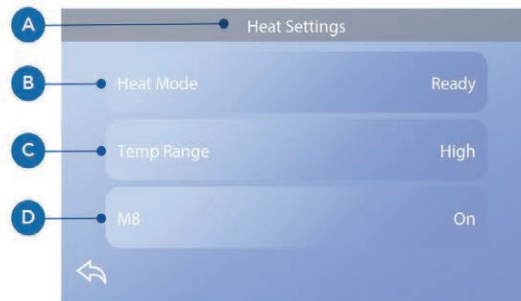

M8

Press the M8 button (D) to turn it On/Off. The M8 feature looks for opportunities to decrease pump usage, which may increase pump life and save energy. M8 is On by default. M8 is an optional feature and may not appear on all systems.



SETTINGS SCREEN

Fine tune your spa with a wide variety of Settings.

Starting from the Main screen, press the Settings button  to view the Settings screen (A). Press the navigation arrows   or swipe to view all of the Settings screens.

Heat

Make sure your spa is heated and ready to enjoy with Heat Settings. (view page 22).

Filter

Keep your spa water clean and ready to enjoy by setting Filter Cycles

Time

Set the Time to ensure scheduled features have proper timing

Reminders

Reminders (A) are helpful spa maintenance messages that display periodically.

Locks

Lock the Panel and/or Setting

Light Cycle (Optional)

If you want the spa lights to turn On and Off at a specific time, use Light Cycle (A).

Hold

Hold (B) is used to disable the pumps during service functions like cleaning or replacing the filter. Hold Mode will last for 1 hour unless the mode is exited manually. If spa service will require more than an hour, it may be best to simply shut down power to the spa. The Hold Icon on the Settings Screen places the spa in Hold Mode and displays the System Hold screen. Touch Back to exit Hold Mode.



Hold (continued)

Drain Mode (Optional)

Some spas have a special feature that allows Pump 1 to be employed when draining the water. When available, this feature is a component of Hold.

Cleanup

When a pump or blower is turned on by a button press, a clean-up cycle begins 30 minutes after the pump or blower is turned off or times out. The pump and the ozone generator will run for 30 minutes or more, depending on the system. On some systems, you can change this setting.

Units

Specify Time and Temperature Units (B). The temperature choices are Fahrenheit or Celsius. The time display choices are 12 hour or 24 hour.

Language

Select from a variety of languages.

Panel

Set how long it takes the panel to go to sleep after the last activity. The default is 1 minute. The shortest time (1 minute) is recommended because it decreases the chance of water activating buttons.

Diagnostics

Spa technicians can find useful information and features in Diagnostics

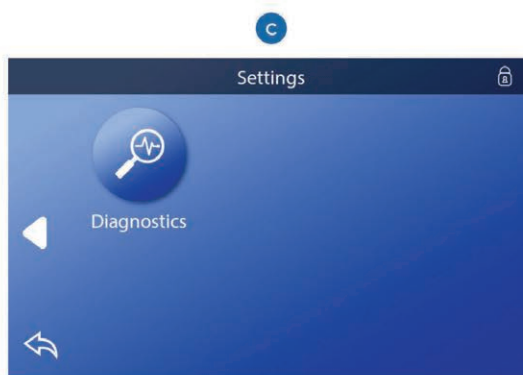
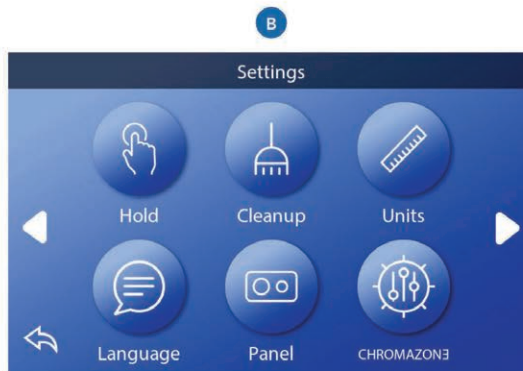

MESSAGES

General Messages

Several alerts and messages may be displayed in a sequence.

Possible freezing condition

A potential freeze condition has been detected, or the Aux Freeze Switch has closed. All water devices are activated. In some cases, pumps may turn on and off and the heater may operate during Freeze Protection. This is an operational message, not an error indication.

The water is too hot – M029*

The system has detected a spa water temp of 110°F (about 43°C) or more, and spa functions are disabled. System will auto reset when the spa water temp is below 108°F (about 42°C). Check for extended pump operation or high ambient temp.

The water level is too low

This message can only appear on a system that uses a water level sensor. It appears whenever the water level get too low (or the water level sensor is disconnected), and automatically disappears when the water level is adequate. Pumps and the heater turn OFF when this message appears.

Heater-Related Messages

The water flow is low – M016**

There may not be enough water flow through the heater to carry the heat away from the heating element. Heater start up will begin again after about 1 minute. See "Flow Related Checks" below.

The water flow has failed* – M017**

There is not enough water flow through the heater to carry the heat away from the heating element and the heater has been disabled. See "Flow Related Checks" below. After the problem has been resolved, reset the message*.

The heater may be dry* – M028**

Possible dry heater, or not enough water in the heater to start it. The spa is shut down for 15 minutes. Reset this message* to reset the heater start-up. See "Flow Related Checks" below.

The heater is dry* – M027**

There is not enough water in the heater to start it. The spa is shut down. After the problem has been resolved, you must reset the message* to restart heater start up. See "Flow Related Checks" below.

The heater is too hot* – M030**

One of the water temp sensors has detected 118°F (about 48°C) in the heater and the spa is shut down. You must reset the message* when water is below 108°F (about 42°C). See "Flow Related Checks" below.

Flow-related checks

Check for low water level, suction flow restrictions, closed valves, trapped air, too many closed jets and pump prime. On some systems, even when spa is shut down by an error condition, some equipment may occasionally turn on to continue monitoring temperature or if freeze protection is needed.

Sensor-Related Messages

Sensors are out of sync – M015**

The temperature sensors may be out of sync by 3°F. Call for Service if this message does not disappear within a few minutes.

Sensors are out of sync -- Call for service* – M026**

The temperature sensors ARE out of sync. The fault above has been established for at least 1 hour. Call for Service.

Sensor A Fault, Sensor B Fault – Sensor A: M031**, Sensor B: M032**

A temperature sensor or sensor circuit has failed. Call for Service.

A pump may be stuck on – M034**

Water may be overheated. POWER DOWN THE SPA. DO NOT ENTER THE WATER. Contact your dealer or service organization.

Hot fault – M035**

A Pump Appears to have been Stuck ON when spa was last powered. POWER DOWN THE SPA. DO NOT ENTER THE WATER. Contact your dealer or service organization.

Reminder Messages

Reminder messages can be reset from the panel. Press the Clear Icon to reset the Reminder message.

System-Related Messages

Program memory failure* – M022**

At Power-Up, the system has failed the Program Checksum Test. This indicates a problem with the firmware (operation program) and requires a service call.

The settings have been reset (Persistent Memory Error)* – M021**

Contact your dealer or service organization if this message appears on more than one power-up.

The clock has failed* – M020**

Contact your dealer or service organization.

Configuration error

The spa will not Start Up. Contact your dealer or service organization.

The GFCI test failed (System Could Not Test the GFCI) – M036**

(North America Only) May indicate an unsafe installation. Contact your dealer or service organization.

General maintenance help

Reminder Messages can be suppressed by using the Reminders Screen. Reminder Messages can be chosen individually by the Manufacturer. They may be disabled entirely, or there may be a limited number of reminders on a specific model. The frequency of each reminder (i.e., 7 days) can be specified by the Manufacturer.

Check the pH

May appear on a regular schedule, i.e., every 7 days. Check pH with a test kit and adjust pH with the appropriate chemicals.

Check the sanitizer

May appear on a regular schedule, i.e., every 7 days. Check sanitizer level and other water chemistry with a test kit and adjust with the appropriate chemicals.

Check ozone

May appear on a regular schedule. Change the UV as instructed by the manufacturer.



Spa Touch 4+ Control System

TOUCH TO START

Your Spa Touch 4+ displays by touching anywhere on the screen. Use your fingertip to touch, tap, scroll, slide or swipe to activate the various icons and images on the panel screen.

You will see a "splash" screen, and then a simple at-a-glance temperature and time status.

NOTE: All features and functions available are shown here. Your system display may vary.

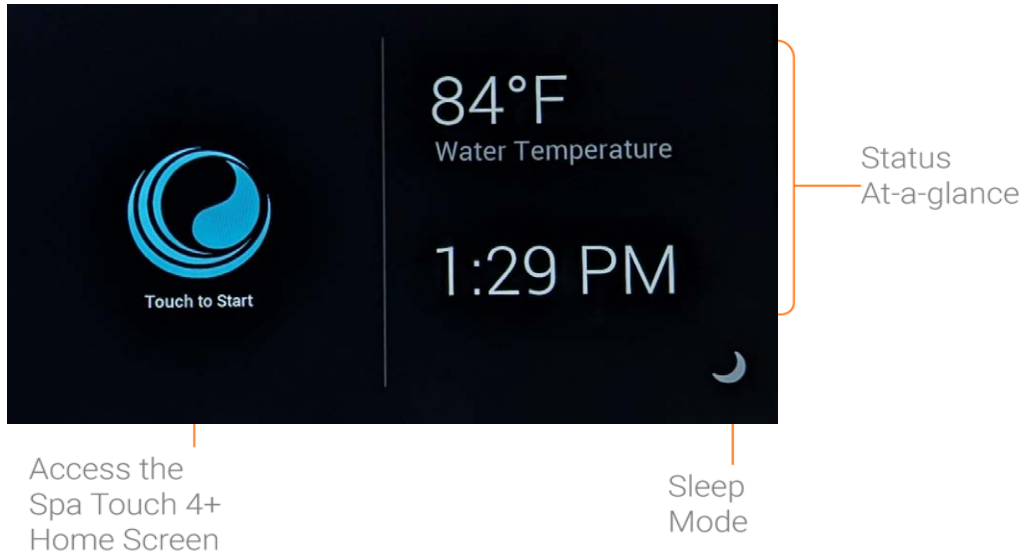

Navigating Menu Icons

NAVIGATING HOME

The Spa Touch 4+ Home screen is your central connection to all your panel offers.



Connected Jets

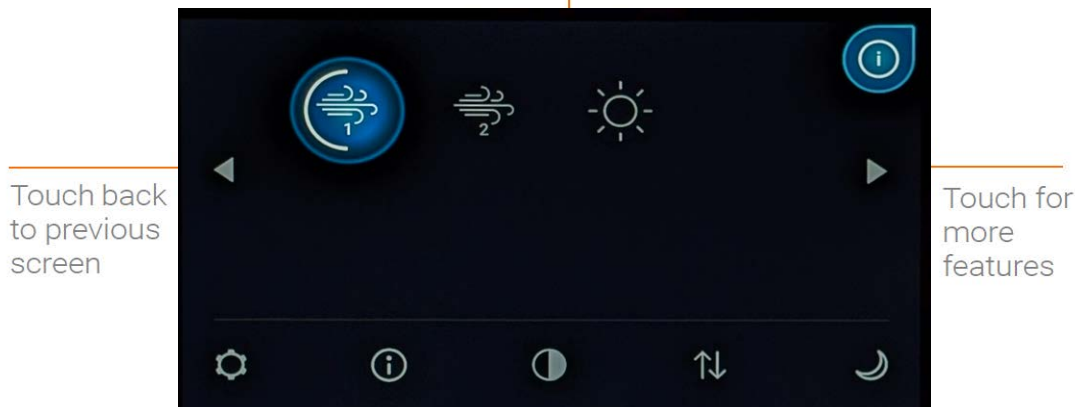

****If you spa was equipped with a circulation pump, it will appear on this screen as a pump icon, with arrows surrounding it.**

You can tap the icon to prime the circulation pump, the pump only activates when heating or during an active filter cycle.

When the display appears like this, the system is in its "Relax Mode" a minimal screen that is appealing to the eyes.

Pressing the "All Off" icon will turn off all components inside of the spa. The home button will present you to the main screen, where you can access the spas pumps and accessories.



Priming Mode

Warning: Prolonged pump operation with an air lock will lead to damage of pumps within your spa. Continued operation would be considered abuse of the spa, voiding the warranty.

To help prevent airlocks from appearing within your spa, fill the spa through the spa filter by inserting inside the filter housing. This allows water to directly go through the primary pump and heater.

Turn each jet on and then off to see that air bubbles are purged. Priming is performed with initial use, and helps to clear waterflow of trapped air or possible stoppage that can strain the system.

To prime the pump:

- 1 Power up the Spa Touch 4+ during initial use to activate the pump priming mode.
The message to prime your spa displays.

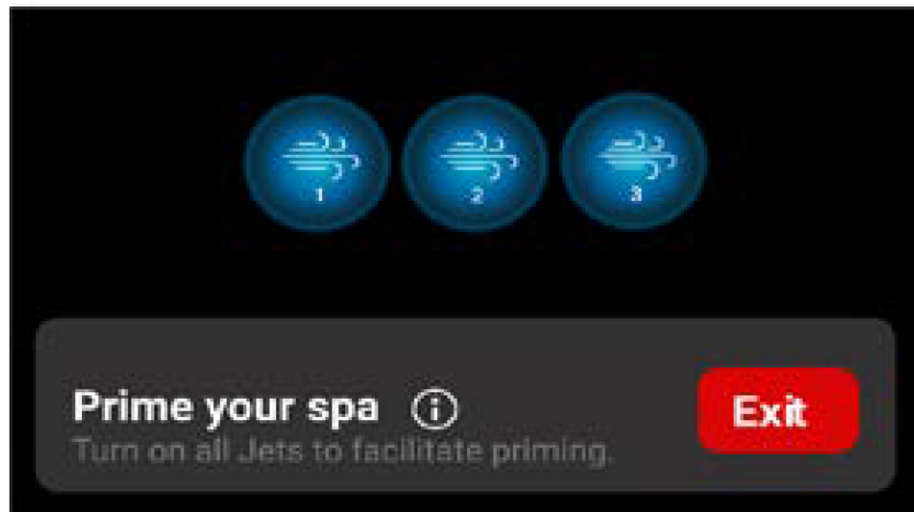

Priming Message

- 2 Touch to turn each jet on and then off to see that air bubbles are purged.
The jets start up and clear air bubbles from the pipes.

NOTE: During priming, you can manually override, and Touch other features lit on the panel. (lights, misters, blower, etc.). Components and features display dimmed cannot be controlled by your panel.

After priming, the spa screen lights connected, active features that your panel controls.

NOTE: At minimum, you will always see one pump active for continuous water flow, and filtration through the system.

Connecting To Wifi

IMPORTANT: Connecting your Spa Touch 4+ to your ControlMySpa account delivers timely updates your system needs for ongoing improvements.

BEFORE YOU BEGIN: Have your Wi-Fi network and password available, and also have your CMS Code available, provided by your spa dealer.

CONNECT WI-FI

To connect to Wi-Fi:

- 1 From Home, touch **Settings**, and then scroll and touch **Wi-Fi**.



Settings Menu

The Wi-Fi Screen displays with available networks.



Wi-Fi Screen

- 2 Touch to connect your spa panel to your Wi-Fi network. A keyboard displays for you to type your network password.



3 Enter your network password and touch **Save**.
"Attempting to connect..." displays, and upon connection, the Wi-Fi screen displays with your newly selected network.

4 Touch **Back** < to return to the **Settings Menu**.

REGISTER YOUR SPA TOUCH 4+

NOTE: This step is needed to enable timely updates and use the *ControlMySpa (CMS) App* from anywhere to control your spa and stay current with the panel display improvements.

To register your Spa Touch 4+:

5 Touch **ControlMySpa**.

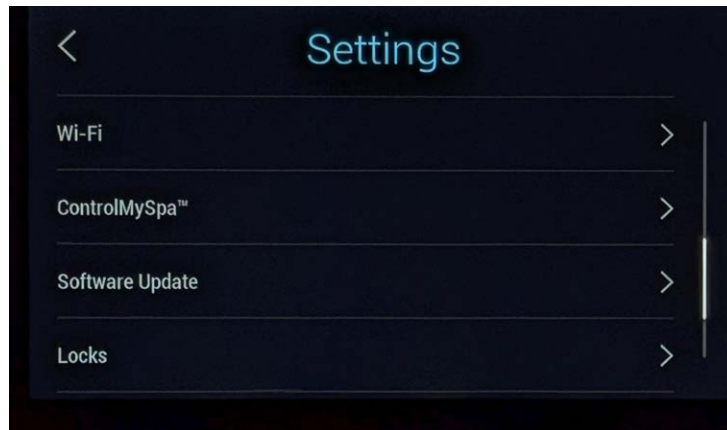

Settings Menu

The ControlMySpa registration screen displays.



ControlMySpa Registration Screen

6 Touch the Edit icon , and the keyboard displays.
Enter the CMS Code supplied by your spa dealer, and then touch **Save**.



Contact your Spa Dealer or Sales Rep to obtain your unique code.



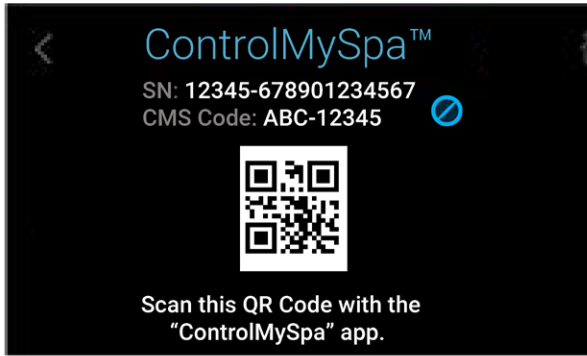

ControlMySpa Screen

- 7 The ControlMySpa screen displays a QR code you will use to pair your spa when you establish your **ControlMySpa** App account. Leave the ControlMySpa screen open on your panel.

Create a ControlMySpa Account

- 8 Using your mobile phone, go to your App store, and download "**ControlMySpa**."
- 9 Follow the in-app prompts to set up an account, and then **Setup Spa**, and be sure to set up your spa account "by QR code."
- 10 Use your phone's camera to scan the QR code displayed on the Spa Touch 4+ panel, and complete **Spa Account Setup**.

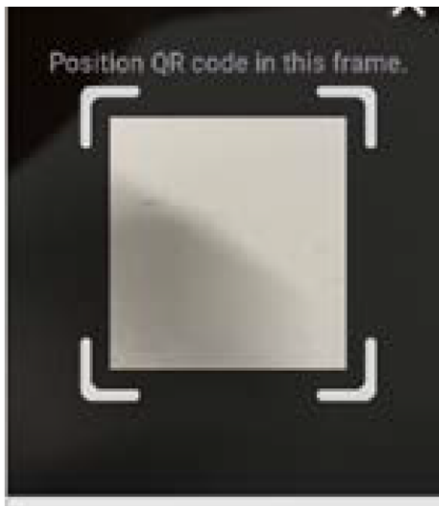

- 11 **IMPORTANT:** When you receive "Account Setup Successful", check your email to authenticate your account.



Setting Time of Day

The time you set displays on the Home Screen, and becomes your system's time, used to automate the duration of other functions, such as filter cycles, activation and water maintenance for reliable performance.

IMPORTANT: An iMessage, ⓘ, displays when the time needs to be set, and turns off after you set the time.

To set the time:

- 1 From the Home screen, touch **Settings** ⚙️, then **Time**.
The Time Screen displays.

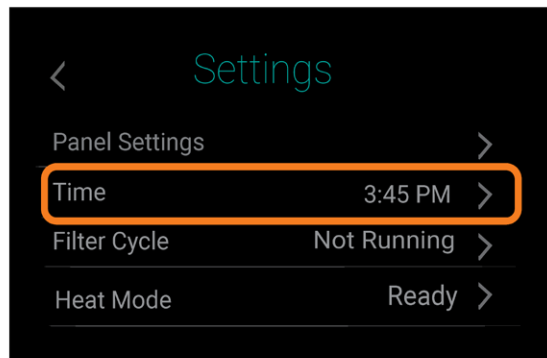

Settings Menu

- 2 Touch and scroll to the current time and **Save**.



Time Screen

The new time is saved, and you can touch **Back** < to set filter cycles next.

Daily filtration assures your spa is operating as designed, and the water is clean and ready to enjoy.

To set the filter cycle times:

- 1 From the Home Screen, touch **Settings**  and select **Filter Cycles**.



Filter Cycles

The Filter Cycles Screen displays the number of cycles you can schedule.

- 2 Touch **Filter Cycle 1**.



Filter Cycles

- 3 Touch **Start** and touch arrows to set the filter cycle starting time. Your desired filter cycle duration adjusts as you make changes.
- 4 Touch **End** and touch arrows to set the filter cycle ending time. Your desired filter cycle duration adjusts as you change it.
- 5 Touch **Save**.
The Filter Cycles screen displays.
- 6 Repeat steps 3 through 6 for additional filter cycles, as needed.
- 7 Touch **Back**  to return to the Home Screen.

Adjust Water Temperatures

Find your current water temperature displayed in large numbers on the Water Temperature reading of the Home screen.

To set the desired water temperature:

- 1 From the Home Screen, touch the **Water Temperature** area of the screen.

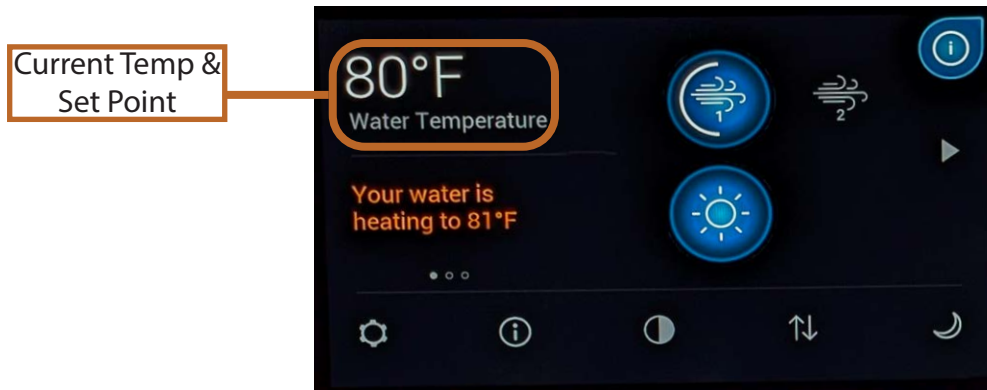

The Desired Temperature screen displays.

- 2 Touch the **plus +** and **minus -** signs or slide the bar along the bottom of the screen.

NOTE: As the system changes the temperature, the panel reading displays in color.

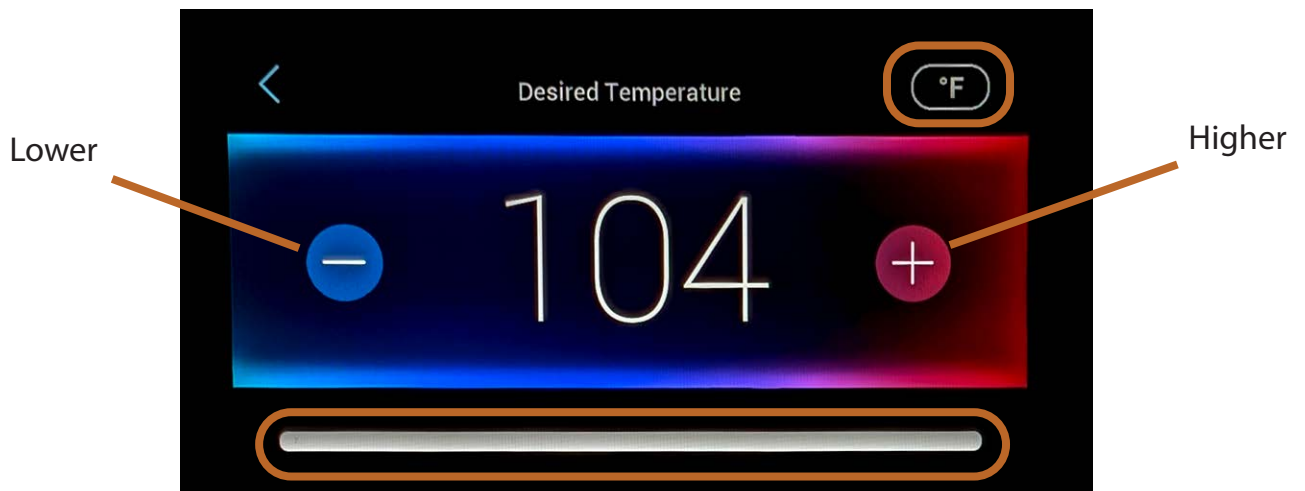

Desired Temperature Screen

- 3 Touch the unit of measure, upper right, and touch Fahrenheit (**°F**) or Celsius (**°C**) and change how water temperature unit of measure is displayed.



The system begins to adjust to the newly set temperature.

- 4 Touch **Back** < to return to the Home Screen.



Turning on the jets provide the water pressure and motion for an enhanced, therapeutic soak.

To turn on the jet:

- 1 From the Home Screen, touch the available **Jet**  to activate, and touch the arrow  to see more features.

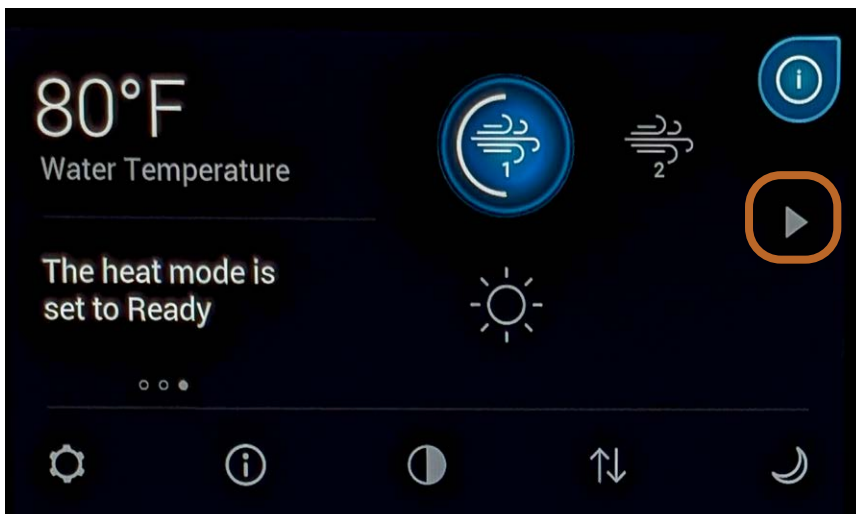

The Spa Features display with additional components connected to your system.

- 2 Touch on each lit jet.



****Some spas are equipped with more than two pumps will show multiple pump icons on the screen, one for each pump**

Spa Features

- 3 Touch the arrow  to display the Home Screen.

Adjust Screen Brightness

Adjust your panel display brightness.

To change the display brightness:

- 1 From the Home Screen, **Settings** ⚙️, touch Panel Settings

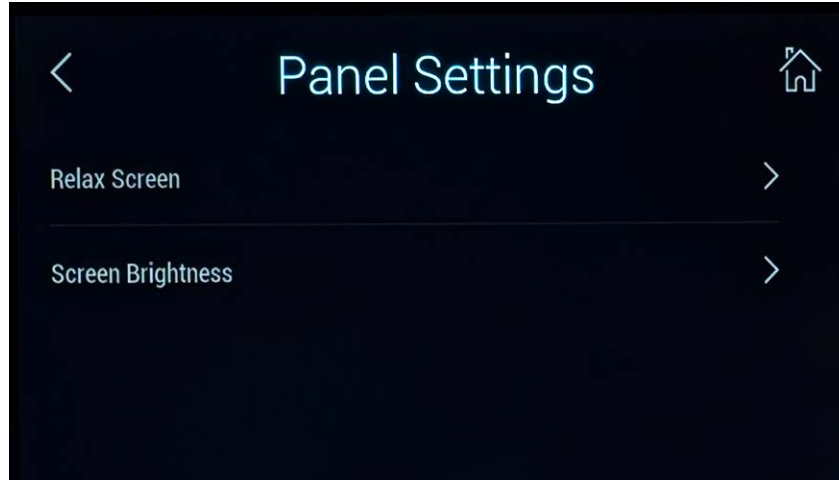

The Screen Brightness slider displays with the Brightness Slider along the screen bottom.

- 2 Touch the **plus** + and **minus** – signs or slide the bar on the screen to adjust your desired level of brightness.

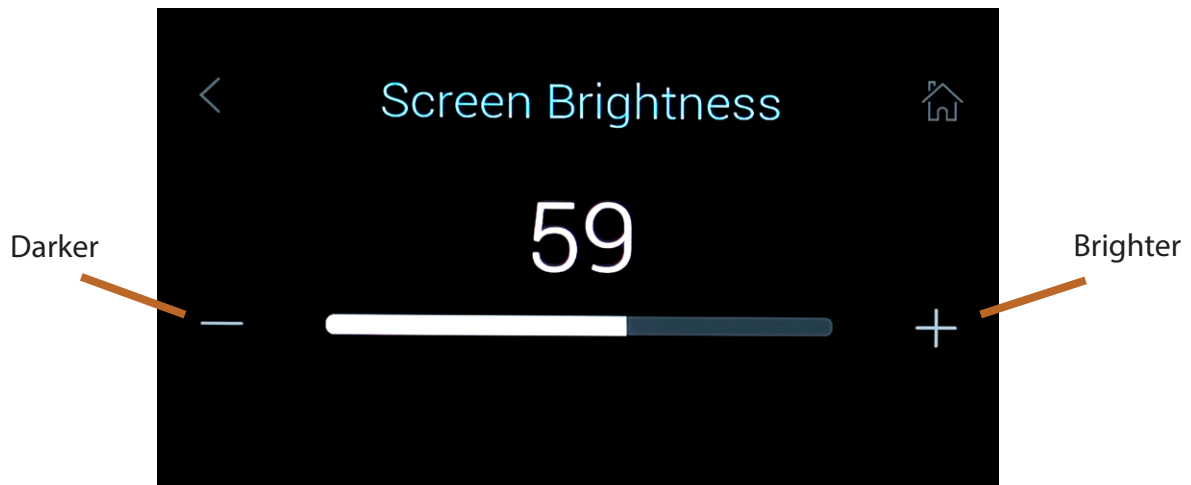

- 3 Touch **Home** 🏠 to return to the Home Screen.



Set Heat Mode

NOTE: All features and functions available are shown here. Your system display may vary.

Keep your spa heated with these options: Run the spa continuously, as Ready (R) state or Rest state (IR) for energy efficiency.

To change the heat mode:

1 From the Home Screen, touch **Settings** ⚙️.

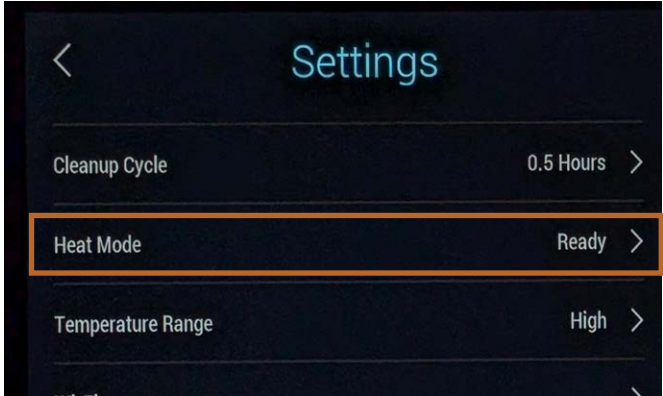

Touch "Heat Mode"

The Settings Menu displays.

2



The Heat Mode Screen displays.

3

Touch to change the Heat Mode. Options are:
Ready - regulates temperature continuously, and best for frequent, scheduled use.

Rest - regulates temperature only during filter cycles.

Ready-In-Rest - When your spa is in Rest Mode, and you touch **Jet 1** 🌊, the system switches to Ready-In-Rest Mode and heats the water to the desired temperature for one hour. Then, the spa returns to Rest Mode.

NOTE: To cancel Ready-In-Rest and return back to Rest Mode within the hour, perform step 3 and select Ready setting.

4

Touch **Home** 🏠 to return to the Home Screen.



Heat Cont.

TEMPERATURE RANGE

Set within two separate temperature ranges, L (Low) and H (High). **High** allows you to set your temperature between two limits in a high range. **Low** allows you to set your temperature between two limits in a low range. The range displays as you set the desired water temperature.

To change the range between High and Low:

- 1 From the Home Screen > **Settings** ⚙️, touch **Temperature Range**.



Settings Menu

The Temperature Range Screen displays.

- 2 Touch either **High** or **Low** to select the range in which the water temperature heats or cools within the range.



Temperature Range

- 3 Touch **Home** 🏠 to return to the Home Screen.



Find your system settings and fault log record here, including System Information and Fault Log.

SYSTEM INFORMATION

To find your system Information:

- 1 From the Home Screen, touch **Settings** , and scroll to touch **Diagnostics**.

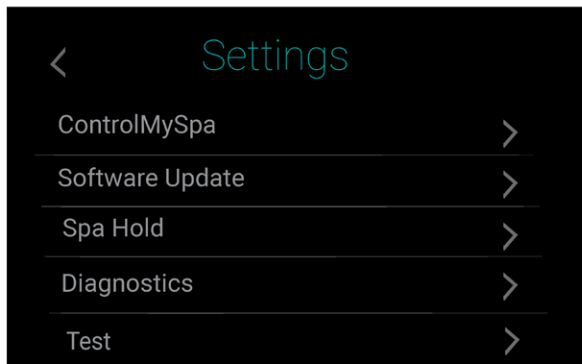

Settings Menu

The Diagnostics Menu displays access to two status pages:

- 2 Touch System Information or Fault Log to see corresponding displays.

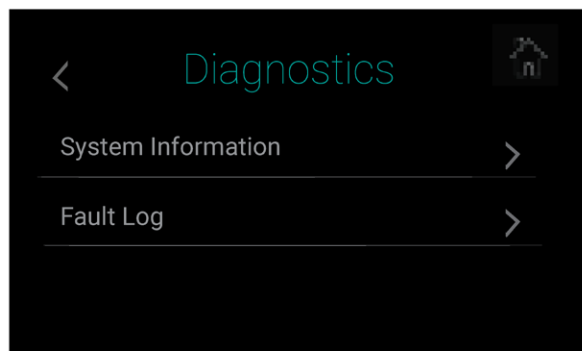

Diagnostics Menu

- 3 Touch System Information or Fault Log to see corresponding displays. Your selected information displays.

66 General Messages & Heater-Related Messages

Water is too hot - M029

The system has detected water temp of 110°F (43.3°C) or more, spa functions are disabled. The system will auto reset when the spa water temp is below 108°F (42.2°C). Check for extended pump operation or high ambient temp.

Water flow is low - M016

There may not be enough water flow through the heater to carry the heat away from the heating element. Heater will attempt to start up again after 1 minute. Correct any water flow restrictions.

Water flow has failed - M017

There is not enough water flow through the heater to carry the heat away from the heating element and the heater has been disabled. After the problem has been resolved, reset the message.

The heater may be dry - M028

Possible dry heater, or not enough water in the heater to start it. Shut down the spa for 15 min to reset this message. Call for service if this message does not clear, as there could be an issue with your sensors or your spa pumps.

The heater is dry - M027

There is not enough water in the heater to start it. The spa is shut down. After the problem has been resolved, you must reset the message* to restart heater start up.

The heater is too hot - M030

This code occurs when, one of the water temp sensors has detected 118°F (47.8°C) in the heater. When this happens the spas current operations will shut down. You must reset the message, and this message will not reappear, when the water in the heater is below 108°F (42.2°C).

Sensor-Related Messages

Sensors are out of sync - M015

When this error code appears, the temperature sensors may be out of sync by 3°F. Call your dealer for service, if this message does not disappear within a few minutes.

Sensors are out of sync - M026

This code is specific to when the system has detected a consistent temperature difference between the sensors of 3°F or more. Contact your spa dealer for service.

Sensor A/B Fault - M031/M032

Either temperature sensor A, B, or both have failed due to a circuit failure. Call your spa dealer for service.

Communications Error

The control panel is not receiving communications from the control system, call your spa dealer for service.

System-Related Messages

Settings have been reset - M021

Contact of spa dealer if this message appears on more than one power up. This could be an internal memory issue.

The clock has failed - M020

The internal clock in your control system has failed. Contact your spa dealer for service.

GFCI Test has failed - M036

Indicates the failure of an automated GFCI self test. This highlights a possible issue with your spas GFCI electrical circuit.

A pump may be stuck on M034

Indicates the failure of an automated GFCI self test. This highlights a possible issue with your spas GFCI electrical circuit.

Hot fault - M035

A pump is possibly in a stuck on position when the spa was last powered on. Meaning the electrical switch controlling the pump is stuck in the on position, ignoring the switch off command. DO NOT ENTER THE SPA, DO NOT ENTER THE WATER. Contact your spa dealer for service.



Reminder Messages

Check the PH

May appear on a regular schedule, i.e. every 7 days. Check pH with a test kit and adjust pH with the appropriate chemicals.

Check the Sanitizer

May appear on a regular schedule, i.e. every 7 days. Check sanitizer level and other water chemistry with a test kit and adjust with the appropriate chemicals.

Clean the Filter

May appear on a regular schedule every 30 days. Rinse the filter cartridge out and gently reinstall.

Test the GFCI

May appear every 30 days. The GFCI is an important safety device that should be tested to verify its reliability.

Change the Water

May appear every 90 days. A general recommendation of draining the spa and using new water to ensure water clarity and proper sanitation. This interval is dependent on spa usage and bather load, this interval might be shorter or longer. Spas with heavy usage may require a water change every 30-60 days, and spas with minimal usage may require a water change every 90-120 days.

Clean the Cover

May appear every 180 days. This reminder is to remind you to clean your vinyl spa cover, and treat the vinyl cover with a spa UV protectant. This will ensure maximum life of your spa cover.

Change the UV

May appear on a regular schedule. The UV light may need to be changed, contact your spa dealer for service.

Change the Filter

May appear on a regular schedule every 365 days. Filters when properly maintained should be changed out every 365 days to maintain proper sanitation.

Check Ozone

May appear on a regular schedule. If your spa is equipped with an ozone system, it is recommended to inspect the ozone generator once a year for proper operation.

Service Check - Up

May appear on a regular schedule. **This does not indicate that the spa is encountering a problem.** This is just a reminder to inspect the operation of your spa and to contact your spa dealer or the manufacture if anything is not operating as designed.

Your new spa comes equipped with a premium 5.5kWh titanium electric heater. Follow the directions listed below, it will help ensure the most efficient spa operation. Some models have the option to combine your spa with a Gecko "in-Temp" heat pump, this information is still relevant to spa owners with either the 5.5 kWh heater or the add on heat pump .

Note: This method is only for spa usage under two hours a week.

- Keep the spa operating temperature about 5F below your usual preferred temperature when not in use. Raise the temperature to your preferred temp about one or two hours before you enter the spa to save on energy costs if your usage is within the range of two hours per week.
- If you use your spa more than two hours a week total, keep the set temperature at your desired temperature.
- The air venturis should be used sparingly when open, water temperature drops depending on ambient temperature as this air is now being injected into the water.

Allowing the water temperature to lower more than 10F below the desired usage temperature, and reheating it prior to usage, will cause the heater to operate longer than keeping the spa about 5F below. This will increase your operating costs. We recommend getting your spa up to your desired temperature, and then lowering the set temperature by 5F once its reaches the desired temperature. Our spas are designed to retain as much heat as possible to ensure your save on long term costs.

**Note: The most electrical power is consumed in the initial fill up, as the tap water needs to be brought up to hot tub temperatures.*

Jets

Almost all of the jets in your spa are adjustable. Rotating the jet face clockwise will increase water pressure, and counter clockwise to reduce pressure on that specific jet. Neck jets are the opposite, with clockwise movement to decrease force, counter clockwise to increase.



LED Lighting

Press the "Light" button on the topside controller to turn the spa light on. If your spa has optional perimeter LED lights, they will also activate.

1. **Cycle:** When you press the "Light" button on and off repeatedly the LED will cycle between a variety of colors that the RGB light can support. Each time you press the button it will immediately advance to the next color in sequence and will eventually enter different light pattern modes.
2. **Flashing:** Once you have cycled through all of the colors, another press of the "Light" button will produce a flashing pattern.
3. **Fading cycle:** The next phase of operation when you push the LIGHT button is a slower and/or fast fade random transition from one color to the next.
 - If a spa is equipped with more than 100 points of light the slow fading cycle will flicker during a color change.
 - Every air valve is equipped with 2 LED points.
 - The waterfall takes 4 points of light. Spas with exterior LEDs work in the same mode as described above. The variations in color and patterns provide you multiple customization options.

LED Under Glow

Certain Cal Spa models are offered with the add on option of our new LED under glow lighting system. This lighting system works alongside the interior spa lighting, whenever the spas main light is activated the under glow will also activate. The color/pattern projecting from the perimeter under glow, will match the color/pattern within the spas interior LEDs.



Diverter Knobs

Diverter knobs are 1" and 2" knobs located around the top of your spa. They allow you to divert water through jets from one side of the spa to the other, of in most cases from floor jets to all jets. This is accomplished by rotating the diverter knob to the left (counter-clockwise), decreasing the amount of water flow through a section of jets. To increase the amount of water flow through the other section of jets, rotate the handle to the right (clockwise)



Air Venturis

Air venturis are the 1" knobs located around the top of your spa. Each one will let you add a mixture of air with the jet pressure. This is accomplished by rotating the air venturi knob to the left (counter clockwise) to increase the amount of air flow. To decrease the amount of airflow through the jets, rotate the handle to the right (clockwise)



Waterfall (Option)



Some Cal Spas are equipped with a waterfall feature, with LED lights inside the housing.

The flow of these waterfalls can be controlled by either the dial on top, and/or a main water diverter.

Pump Button (On/Off):

Press the "Pump" button to activate the ATS system. The pump will turn on full speed with letter "H" displayed in the LCD panel, the pump LED light will turn on. Press the pump button a second time to turn off the ATS system. In order to use the pulse features within the ATS system you must press "Pump" button before pressing "Pulse".

Pulse Mode Button:

Once the main pump is activated and is running on H mode, press the "Pulse" button. The previously selected pulse mode number will appear on the LCD screen. There are a total of 9 pulse modes, this can be changed using the "Up" and "Down" buttons. You may press the "Pulse" button again to exit pulse mode and enter high speed "H" mode.

Up/Down Buttons:

These Buttons only function when the ATS system is in pulse mode. When toggling the "Up" and "Down" arrows cycle through 9 modes and a demo mode "d". In demo mode the seat will cycle through all 9 modes for 30 seconds on each number. You can exit demo mode by pressing the "Up" & "Down" arrows or allow demo mode to complete all 9 thirty second cycles.

Time Out:

The pump has an automatic shut off after 15 minutes of continuous operation. When using any selected pulse mode the mode will last for only 15 minutes. If you plan to use the ATS system for an extended period of time the following section will explain how to use the system without engaging the overheat protection of the ATS pump.

Pump Protection:

When the pump is set for any pulse mode, the pump will surge in temperature. The pump is designed with an overheat protection to ensure longevity of the system. To avoid the thermal cut out from activating you may select a pulse mode, after the first mode ends press the "Pump" button for high speed for at least 5 minutes. When the pump will rapidly cool when set to high speed mode. After 5 minutes of use you can once again press the "Pulse" button and select your next massage mode.

Note: Always activate the high speed pump between therapy numbers to prevent the pump from overheating.

Pump Purge:









To prevent water stagnation within the ATS plumbing, The ATS pump will kick on once a day to purge. This occurs every 24 hours and will run for 20 seconds, showing a "P" on the display.

ATS Temp Sensor:

The ATS sensor is used to monitor temperature to prevent the ATS system from freezing or overheating. If the temperature is too cold the pump will kick on full speed and show "F" on the display to prevent freeze damage. If the system is too hot, all pump operations on the ATS seat deactivate and the letter "C" will appear on the display. Depending on temperature the pump may activate in high speed mode to cool the pump down, the thermal cut out may activate, and will stop all pump operations for 30 minutes.

If there is a sensor issue a flashing letter "E" will display on the controller. The ATS system will operate for one cycle but after the 15 minute cycle ends a flashing "L" will display on the controller. Contact your dealer for service to replace or fix the sensor within the ATS system.



- 1  Low rolling bursts
- 2  Medium continuous bursts
- 3  Accelerated continuous bursts
- 4  Swift rolling bursts
- 5  3 gentle bursts followed by 1 vigorous burst
- 6  Quick, powerful continuous bursts
- 7  Gentle, powerful alternating bursts
- 8  Medium low rolling bursts
- 9  Extended low rolling bursts

Massage Pump

Some spas have the option to install a variable speed pump, with its own independent control panel. This control panel is used for our Throttle Seat™ massage therapy seat. This Throttle Seat™ has the ability to pulse and activate the variable speed pump on an interval, to massage the body of the user sitting in a seat. The following section will provide information on operation of the Throttle Seat™ system, its control panel, and modes/adjustments that can be done to personalize your hydrotherapy experience.

The Flx-Go control panel, is a fully independent control panel for the Throttle Seat™ system within your spa.

Note: *Selecting options such as setting the temperature and filter cycles within this control panel, will not affect actual spa operation.*

Keypad layout

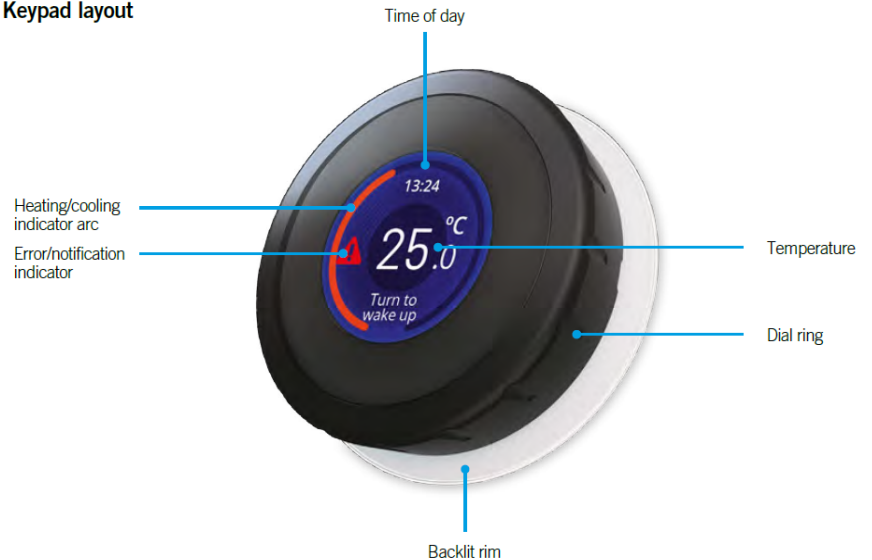

Power

Rotate the dial ring of the flx.go to turn on the keypad. After 2 minutes of inactivity, the keypad will revert to the sleep mode screen and after 4 minutes of inactivity, the screen will shut off.

Navigation

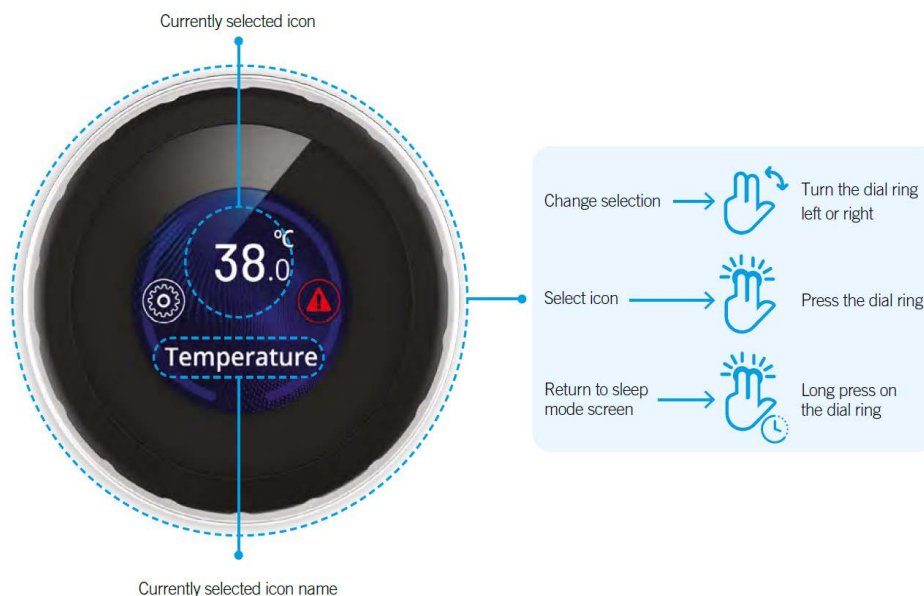

Navigation:

To navigate between functions and screens, the controller uses intuitive hidden physical switches to activate pumps, adjust settings, and operating other modes.

Use the rotating exterior bezel to navigate through options within the controller.

You may select an option by pushing down against the entire control panel, the whole controller functions as one large button.

VMS-1 variable-speed pump



Using the rotating bezel, you may find and select the Variable Speed Pump option. Press down on the controller to select this option.

You may use the rotating bezel to increase or decrease the spa pumps water flow.

Select "Massage" to see all available massage patterns within your throttle seat, the primary VMS Pump is labeled with a "1" in its icon.

Message Menu

There are several different massage modes you can choose based on your preferences. Modes vary from rigorous water movement, to slow therapeutic rolling movements.



Once you have found your desired massage mode, press down on the controller.

Message Adjustments



After selecting a massage mode within your Cal Spas Throttle Seat, you may fine tune your experience, by adjusting the pumps intensity or adjusting the rhythm of the massage to your preference.

Once you have fine tuned your desired adjustments, rotate the bezel to the name of the selected massage with "Press to start" displayed on the icon. Press down on the controller to begin the massage cycle.

- Once the massage type has been selected these pages will allow you to adjust the rhythm and intensity of your massage. Rhythm can be adjusted on 5 levels, intensity if set the same way as the in the menu of your variable speed pump, you can also start and stop your massage via this menu.

Flip Display



- You can press the flip display button to rotate the display 180 degrees.

Note: Certain options like "Lights" within this control system, are not intended to function. The throttle seat uses its own independent control system, the primary control system controls filtration, lighting, heating, and all other spa feature.

The settings menu gives you access to several different options to help operate your spa.

Note: The throttle seat is fully independent of the spa, changing certain settings within the controller may not affect the entire spas operation.

Settings



The Throttle Seat uses its own dedicated control box, using the powerful brains of the control system to provide reliable and consistent operation of the seats massage modes. Due to this some options appear within the spas control system, that are not actually present within the Throttle Seat.

This section provides some guidance on troubleshooting the Throttle Seat with its unique behavior compared to other control systems.

Note: *The Throttle Seat control box does not receive commands from the main spa controller. The Throttle Seat control system only gets 220v power from the main control box terminal.*

Problem	Solution
My Throttle Seat stays activated, even when the seat is not in use.	<ul style="list-style-type: none"> • The throttle seats set temperature was raised above 60F. Lower the throttle seats temperature to 60F. The throttle seat does not contain an active heating system, this may confuse the pump system and can cause the throttle seat pumps to activate constantly. • Temperature adjustments in the Throttle Seat do not affect the heating temperature of the spa. • Keep the set temperature to 60F. Do not raise.
The Throttle Seat activates for a few seconds randomly every few minutes/hours.	<ul style="list-style-type: none"> • The throttle seats control system is currently conducting a purge cycle, this is considered normal operation if the pump remains activated for less than 60 seconds. • Verify the intensity % set on the Throttle seat is set to 0% when not in use.
How do I turn off the control screen when using the throttle seat?	<ul style="list-style-type: none"> • With your fingers/hand, press down on the display and hold for about 5-8 seconds. This will turn off the display.
Does the Throttle Seat have a filter?	<ul style="list-style-type: none"> • The throttle seat is designed to move large volumes of water at fluctuating rates, due to this the throttle seat is connected through a high flow suction fitting designed to prevent large debris and hair from entering the system. • Only the spas primary controller controls the filtration capabilities of the entire spa.



This section is intended for new spa owners who are not familiar with adjusting spa water chemistry. Everyone's knowledge with maintaining water quality is different, but there are some general concepts you need to know.

Water maintenance is not difficult, however it is something that requires regular attention. The most important thing to understand about taking care of your spa water, is that preventative action is easier than corrective action when balancing chemistry and maintaining water clarity

Before beginning, we recommend you become familiar with some water quality terms and their definitions within this following section.

1. Chemical Balancing

Learning how to properly balance your water.

You will need to test and adjust the chemical balance of your spa water, this is not a difficult task but it must be done regularly. Important areas to focus on with water chemistry is the calcium hardness, total alkalinity, and the pH range.

Spa owners with salt generators will need to perform a total dissolved solids and phosphate test.

3. Filtration

Learn how to properly clean your filter

Cleaning your filter cartridge is the easiest and most effective thing you can do to keep your spa water clear.

A clogged dirty filter will cause the heater and pump to work harder than they need to, possibly causing them to fail.

The spa's heating system will only function with the proper amount of water flow through the system.

2. Sanitation and Shock

Learning how to properly sanitize and shock your spa.

Sanitizers kill bacteria and viruses and keeps your water clean. A low sanitizer level will allow microbes to grow quickly in the spa water . We recommend using either granulated chlorine or bromine as your sanitizer.

You also need to add shock to the water to stimulate the chemical sanitizer. How much you use and how often you use sanitizers, depends on how frequently the spa is used.

4. Consistency

Make checking your spa part of your daily routine.

Clear water requires regular maintenance. Establish a routine based on a regular schedule, testing your water on a daily basis.

Maintaining your water quality helps the enjoyment of your spa and extends the lifetime of spa components by preventing damage from neglect and chemical abuse.

The following chemical terms are used in this section. Understanding their meaning will help you to better understand clear water maintenance. Words in bold type are defined in this table.

Bromine / Bromamines	<p><u>Bromine</u> is an efficient sanitizer chemical for spas. When used as a sanitizer, bromine forms compounds called bromamines. Bromine can be added to the spa or automatically generated.</p> <p><u>Bromamines</u> are compounds formed when bromine combines with nitrogen from body oils, perspiration, etc. Unlike chloramines, bromamines have no pungent odor and are effective sanitizers.</p>
Chlorine / Chloramines	<p><u>Chlorine</u> is an efficient sanitizing chemical for spas. We recommend using sodium dichlor-type granulated chlorine because it is totally soluble and nearly pH neutral. When used as a sanitizer, chlorine forms compounds called chloramines.</p> <p><u>Chloramines</u> are compounds formed when chlorine combines with nitrogen from body oils, perspiration, etc. Chloramines can cause eye irritation as well as having a strong odor. Unlike bromamines, chloramines are weaker, slower sanitizers. To remove chloramines, see the description of shock below.</p>
Calcium Hardness	Abbreviated as CH. Calcium hardness is a measure of the total amount of dissolved calcium in the water. Calcium helps control the corrosive nature of the spa's water and is why soft water is not recommended. The low CH level can cause corrosion to the equipment and can cause staining of the spa shell.
Corrosion	The gradual wearing away of metal spa parts, usually caused by chemical action. Generally, corrosion is caused by low pH or by water with levels of TA, CH, pH or sanitizer which are outside the recommended ranges.
Dichlor	Also called sodium dichlor. It is a type of chlorine and is frequently used when shocking the water . An effective chlorine -based powdered oxidizer and sanitizer . Dichlor works by oxidizing waste product in the water such as bromamines and chloramines and causing them to burn off.
Monopersulphate or MPS	Frequently used when shocking the water . An effective non-chlorine-based powdered oxidizer that works well with both chlorine and bromine . It works by oxidizing waste product in the water such as bromamines and chloramines and causing them to burn off.
Oxidizer	Shocking the water with an oxidizing chemical prevents the buildup of contaminants, maximizes sanitizer efficiency, minimizes combined chlorine and improves water clarity.
Ozone	Ozone is a powerful oxidizing agent which is produced in nature and artificially. Ozone forms no by-products of chloramines (ozone actually oxidizes chloramines) and will not alter the water's pH .
pH	The pH level is the measure of the balance between acidity and alkalinity. Low pH causes the water to be too acid, which will cause corrosion , whereas high pH causes the water to be too alkaline, which will cause scaling . See page for testing for and balancing pH.
ppm	The abbreviation of "parts per million", the standard measurement of chemical concentration in water. Identical to mg/l (milligrams per liter).
Sanitizer	Sanitizer is a chemical added to the water to kill bacteria and viruses and keep the water clean. The two sanitizers we recommend are chlorine and bromine

Scale	Rough calcium-bearing deposits that can coat spa surfaces, heaters, plumbing lines and clog filters. Generally, scaling is caused by mineral content combined with high pH . Additionally, scale forms more readily at higher water temperatures.
Shock	Also called shocking the water, shock treatment, or superchlorination. Shocking the water is adding significant doses of dichlor or MPS to oxidize non-filterable organic waste and to remove chloramines and bromamines . Shock treatment breaks down organic waste contaminants which cause odor and cloudy water.
Total Alkalinity	Abbreviated as TA. Total alkalinity is the measure of the total levels of carbonates, bicarbonates, hydroxides, and other alkaline substances in the water. TA is important for pH control. If the TA is too low, the pH will fluctuate out of control, and if it is too high, the pH becomes difficult to stabilize.
Trichlor	Used as a pool sanitizer . NEVER use trichlor in a spa. Trichlor is extremely acidic and will lower the pH , causing corrosion to equipment. Using trichlor will void your warranty.

Water Testing Methods

There are two testing methods to choose from:

Test strips are a convenient testing method commonly used by spa owners.



The reagent test kit is a method which provides a high level of accuracy but is more expensive and more difficult to use if not experienced with this testing method.



Adding Chemicals to the Spa

IMPORTANT: All spa water chemicals, including MPS (Shock), chlorine, granulated pH increaser or decreaser, granulated total alkalinity increaser, calcium hardness increaser, liquid stain and scale inhibitor, and liquid de-foamer must always be added into or in front of the filter compartment while the primary jet is running for a minimum of 10 minutes.

1. - Fold back the cover.
2. - Press the Jets button or Jet 1 button (Touch devices, activate pump 1)
3. - Carefully measure the recommended amount of chemical and slowly pour it into the filter area. Use care not to splash chemicals on your hands, clothes, eyes, or spa surface/siding
4. - Close the spa cover

Warning: High sanitizer levels can cause discomfort to the user's eyes, lungs, and skin. Always allow the sanitizer level to fall into the recommended range before using the spa.

IMPORTANT NOTE REGARDING SHOCK TREATMENT: After administering shock to your spa, leave the cover open for a minimum of 20 minutes to allow the oxidizer gas to vent into the atmosphere. A high concentration of trapped oxidizer gas which may exist as a result of the shock treatment (not daily sanitation), may eventually cause discoloration or vinyl degradation to the bottom of the cover. This type of damage is considered chemical abuse, and is not covered under the terms of the limited warranty.

Maintaining spa water chemistry can be tricky, especially since there are many methods of keeping your water clear and clean. Note: We do not recommend a specific brand of chemicals.

See a spa dealer for guidance and recommendations on spa chemicals and supplies needed, as water chemistry varies from region to region. Various chemicals often sold under brand names, but a spa dealer can advise you on generic chemicals that are often less expensive than proprietary brands.

Balancing the Total Alkalinity (TA)

Total Alkalinity is a measure of the total levels of carbonates, bicarbonates, hydroxides, and other alkaline substances in the water. TA is referred to as the water's "pH Buffer". In other words, it's a measure of the ability of spa water to resist chemical changes in the pH level.

If the TA is too low, the pH level will fluctuate widely from high to low. Fluctuations in pH level can cause corrosion or scaling of the spa components. Low TA can be corrected by adding sodium carbonate (pH/Alkalinity Up).

If the total Alkalinity is too high, the pH level will tend to be high, and may be difficult to bring down. It can be lowered by using sodium bisulfate (pH/Alkalinity Down).

Once the TA is balanced, it normally remains stable, although the addition of more water with a high or low alkalinity will raise or lower the TA reading of the water.

When the Total Alkalinity is within the recommended range, proceed to the next step.

Balancing the Calcium Hardness (CH)

Calcium Hardness is a measure of the total amount of dissolved calcium in the water. Calcium helps control the corrosive nature of spa water, that's why Calcium - low water (Soft Water) is not recommended. It is very corrosive to the equipment and can cause stains in the spa shell.

If the CH is too high (Hard Water) formation of scale on the spa shell & surface can result. You can use a generic calcium remover to remove hardness from water. CH can also be decreased by dilution (75% Hard water, 25% Soft water) will usually yield a reading within the correct range. If soft water is not available or practical for you, a stain and scale inhibitor should be added to the spa water, according to label instructions.

**If the CH is too low, add CH Increaser.

Once the CH is balanced, it normally remains stable, although the addition of more water with a high or low calcium content will raise or lower the CH reading of the water.

When the CH is within the recommended range, proceed to the next step.

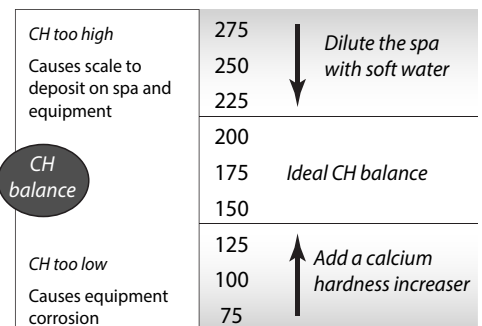
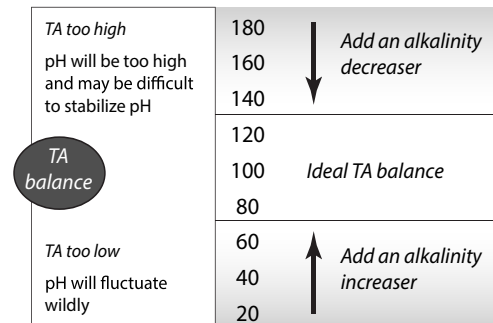

Balancing the pH

The pH level is the measure of acidity and alkalinity. Values above 7.8 are alkaline; those below 7.2 are acidic. Maintaining the proper pH level is extremely important for optimizing the effectiveness of the sanitizer, maintaining water that is comfortable for the user, and preventing equipment deterioration.

If the spas water's pH level is too low, the following may result:

The sanitizer will dissipate rapidly

- The water may become irritating to spa users
- The spas equipment may corrode
- Bacteria and algae spikes can occur.

If the pH is too low it can be increased with sodium hydrogen carbonate (pH/Alkalinity Up) to the spa water.

If the pH level is too high, the following may result:

- The sanitizer is less effective
- Scale will form on the spa shell surface and equipment
- The water may become cloudy
- The filter cartridge may become obstructed.

If the pH is too high, it can be decreased by adding sodium bi-sulfate (pH/Alkalinity Down) to spa water.

Note: After adding sodium hydrogen carbonate or sodium bi-sulfate, wait two hours before testing the spa water again for pH. Compounds take time to fully dissolve into the spa water, initial reading may not be accurate

Its important to check the pH on a regular weekly basis. The pH will be affected by the bather load, the addition of new water, the addition of various chemicals, and other sanitizer used. When the pH is within the recommended range, proceed to begin the sanitation process.

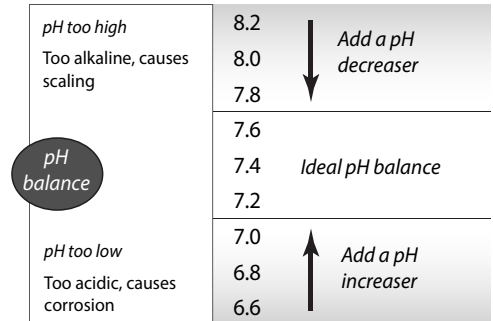

Sanitation and Shock

Sanitizers kill bacteria and other organic waste by breaking them down to non-harmful level which are filtered out. Before you fill your spa, you need to decide which chemical sanitizer you wish to use. Consult your Cal Spas dealer for the right decision with regards to your lifestyle and spa usage.

We recommend granulated chlorine or bromine as your sanitizer. Both work well when maintained regularly

Note: DO NOT USE Trichlor. Trichlor is very acidic and the hot temperature of the spa causes it to dissolve too fast, it will cause damage to your spa and will void your warranty.

Whichever chemical you decide to use, do not take shortcuts. It will provide you with clean, safe, clear, spa water with a minimum of effort. Spa owners with an ozonator still need to use a chemical sanitizer. Whenever you test chemical levels, your test strip will likely have a test for chlorine or bromine. Make sure you sanitizer falls within the range shown on the next page.

Whenever you test your chemical levels, your test strip will likely have a test for chlorine or bromine. Make sure your sanitizer falls within the range shown on the next page.

If your spa is equipped with a ozonator, this will assist in breaking down organic material and odors, but it will not disinfect your water, following the standard ppm recommendation for the sanitizer of choice is mandatory.

After you choose a sanitizer, you will need to establish a baseline and maintain it regularly.

Sanitizing your spa with chlorine or bromine is very similar. Each sanitizer has its advantages and disadvantages. Sanitizer helps neutralize bacteria that can cause illness and other organic matter.

Bromine: Creates less odor and skin irritation than chlorine, bromine is less likely to do so. Additionally, unlike chlorine when bromine combines with bather waste and other contaminants in the water it remains an effective sanitizer. Bromine is also far less pH dependent than chlorine. Always remember that bromine itself is not a sanitizer, it needs to be activated with a bromine shock chemical in order to be effective, speak with your spa dealer for more information.

Chlorine: The most commonly recognized sanitizer is chlorine. However, the effectiveness of chlorine depends heavily on the pH level of the spa water. In order to get the most effective and economical benefit of chlorine, you must maintain a consistent pH level of between 7.2-7.6; a disadvantage of using chlorine is that when chlorine combines with bather waste and other contaminants, not only does it lose its sanitizing ability, it can cause odors and irritate eyes and skin to individuals with sensitive skin or prolonged spa exposure.

Testing For:	Ideal Range (ppm)	
	Minimum	Maximum
Chlorine Level	3.0 - 5.0	
Bromine Level	6.0 - 11.0	

Note: If you choose to use bromine or chlorine we do not recommend the use of a floater. You have more control over the sanitizer levels by adding sanitizer as needed. Chemical abuse will void your warranty. When adding sanitizer to your spa, ensure that pump one is operating at high speed, and feed the sanitizer into the filter canister with the most suction, for spas with more than one pump we recommend activating all pumps for at least 10 minutes when adding sanitizer.

Starting with fresh water/pre-filtered well water:

1. Establish a baseline by adding either granulated chlorine or bromine.
 - Use a half ounce of chlorine for every 500 gallons of water
 - Use half an ounce of bromine for every 100 gallons
2. Run the Jets for 10 minutes (Press/toggle the pump 1 button/icon)
3. Test the water, make sure the pH, TA, and CH levels all fall within the ranges shown in the previous pages, make adjustments as needed.
4. After balancing the water, if you are using bromine to sanitize your spa, you must activate your bromine. You will need to shock-oxidize the bromine inside of your spa. Depending on the size of your spa, usually you must add one to two ounces of shock, refer to the instructions inscribed in your chemical of choice.
5. Test the water again, when the water is balanced, your spa is ready to use.

Shocking the Water

In addition to using a chemical sanitizer, you will periodically need to shock the water. Shocking the water helps remove burned-out chemicals, bacteria, and other organic material from your spa's water and improves your sanitizer's effectiveness.

Do not use chlorinating shock, which can damage the spas jets and pump seals. Only use Oxidizer shock. It can be used with either bromine or chlorine sanitizers.

Add two ounces of oxidizer shock per 500 gallons once a week, after heavy bather loads, or if the water has a strong odor. The spa must be running with all of the jets on high for 30 minutes with the cover open. If necessary repeat the oxidizer shock in 30 minute intervals.

Filtration & Cleaning

The filter is the part of your spa that removes big and microscopic debris from the water to maximize your spas water clarity. Regular maintenance must be done to maximize the spas filtering performance and heat efficiency.

It is extremely important that you never run the spa without a filter, there is a possibility that debris may be sucked into the plumbing, damaging the spa pumps and heater.

Cleaning the Filter

In addition to spraying the filter down with a hose to remove surface debris, the filter must be deep cleaned every so often to dissolve scale and particles that are trapped within the pleats of the filter. Even if the filter looks clean, scale and other particles hide deep within the filter fibers restricting water flow. If the filter is not properly cleaned this will cause flow issues within the spa heater creating a heater malfunction. We recommend cleaning your filter at least once a month or every two weeks depending on spa usage.

Cleaning the filter

1. Remove the filter by unscrewing the filter counterclockwise from the top of the filter, do not use excessive force when removing or installing the filter.
2. Place the dirty filter into a bucket of water where the filter is completely submerged in water. Add the desired filter cleaner of choice, on average most manufactures recommend 8 ounces of chemical cleaner, verify the amount used on your chemical instructions.

Note: It is recommended to obtain a spare filter to use in the spa when performing maintenance on the dirty filters. This way you can rotate the filters and extend their lifespan.

3. Soak the filter for a minimum of 24hrs
4. Spray the filter with a water hose, with careful attention between filter pleats.
5. Reinstall the filter, Do not over-tighten.

Prior to each use	Test the spa water. Adjust chemical levels as necessary. Shock the water by adding ½ teaspoon of sodium dichlor per 250 gallons or 1 teaspoon of MPS per 250 gallons.
After each use	Add an ounce of oxidizer after heavy bather loads
Once a week	Check the filter well and inside the filter pipe for leaves and foreign matter. Test the spa water. Adjust chemical levels as necessary. Shock the water by adding ½ teaspoon of sodium per 250 gallons or 3 teaspoons of MPS per 250 gallons. If your water source is high in calcium, add stain and scale preventer.
Every two to four weeks	Deep clean your spa's filter . How often you clean your filter depends on how much you use your spa. There is no harm in frequently cleaning your filter and will only help your spa's efficiency.
Every two to four months	Change the spa water. How often you change the water depends on how much you use the spa. When you change the water, you will need to: <ul style="list-style-type: none"> • Clean and polish the acrylic surface • Clean and treat the spa cover and pillows • Deep clean the filter • Refill your spa
Each time you refill the spa	Follow the section "Filling and Powering Up Your Portable Spa"

Generic Names for Chemicals

Water Chemistry		
Common name	Usual chemical name	Common brand names
pH Up	sodium hydroxide	pH Increaser, pH Up, pH Plus, pH Booster
pH Down	sodium bisulfate sodium bicarbonate (baking soda) sodium carbonate	pH Decreaser, pH Down, pH Minus, pH Subtractor, Dry Acid
Alkalinity increaser	sodium carbonate sodium bicarbonate (baking soda)	Alkalinity Increaser, Alkaline Up
Alkalinity decreaser	sodium bisulfate	Alkalinity Decreaser, Alkaline Down
Calcium increaser	calcium chloride	Calcium Increaser, Calcium Up, Calcium Plus, Hardness Increaser
Calcium decreaser	N/A To decrease calcium hardness, drain several gallons of water from the spa and refill using a mixture of 75% hard water and 25% soft water, or use a stain and scale inhibitor.	

Sanitizers

Common name	Usual chemical name	Common brand names
Chlorine	sodium dichlor	Both chlorine and bromine are available under numerous brand names
Bromine	sodium bromide	

Shock

Common name	Usual chemical name	Common brand names
MPS	monopersulphate	MPS Shock, Oxy-Spa, SeaKlear
Dichlor	sodium dichlor	Dichlor Shock

Note: Dichlor (chlorine) is both a sanitizer and a shock. Monopersulphate (MPS), when used as a shock, can be purchased alone as non-chlorinated shock or combined with dichlor, which makes it significantly more effective than MPS alone.

Other chemical additives

Common name	Usual chemical name	Common brand names
Stain and scale inhibitor	These are usually proprietary chemical formulations and cannot be purchased as a single generic chemical.	Metal Stain Gone, Scale Inhibitor, Stain and Scale Preventer, Stain and Scale Defense
Foam inhibitor		Foam Gone, Foam Down, Defoamer
Clarifier		Water Brite, Spa Bright, Water Clarifier, Clear Water, Natural Clarifier, Brite & Clear

Do NOT use these in your spa:

- Sodium hypochlorite (household bleach)
- Trichlor

Common Water Chemistry Questions

Question : Why is the use of a floater not recommended to sanitize my spa water?

Answer: We do not recommend the use of a floater for three reasons:

- The floater is unable to control the rate at which the sanitizer is dissolved into the water. When a floater is placed into a spa the sanitizer levels inside the spa can be extremely high. High sanitizer levels over a period of time will cause chemical burns and discolor the spa shell, jets, pillows, and spa cover underside. The use of floaters tends to lead to negligence of spa water sanitizer levels as well. Once the sanitizer is all dispensed and the floater is not checked daily, the low sanitizer level will allow viruses, algae and harmful bacteria like Legionella (Legionnaires disease) and E-Coli to grow.
- Floaters tend to stay in one area of the spa most of the time, causing this area to be exposed to extreme sanitizer levels. Most commonly a floater will become trapped near the filter weir or a seat, causing chemical damage to the section of the spa.
- The floater may allow small chunks or pieces of the concentrated sanitizer to fall out of its housing causing the chunks to settle at the bottom, causing pitting or chemical blisters to the spa shell. For this reason we advise you to use granulated chlorine or bromine as granulated sanitizers are designed for dissolve quickly inside of the spa with your jets activated. Chemical abuse is not covered under the terms of the limited warranty.

Question : When I open my spa, I smell chlorine. How to I get rid of the smell?

Answer: There are two types of chlorine in your spa. the first is "Free Chlorine" which is chlorine molecules that are available to sanitize your spa. This free chlorine does not have an odor. The second is chloramine, which is a byproduct of chlorine that has already been used/expended to sanitize. Chloromanes generate the strong chlorine smell most spa owners experience. This can be eliminated by shocking your spa water, if you smell chlorine in the water, its time to shock.

Question: Why can't I fill my spa with soft water?

Answer: Soft water is essentially the same as regular water except in one regard that is important for spa chemistry and that is calcium levels. The calcium inside of the water has been replaced by sodium, which can be corrosive to heaters, pumps, and other plumbing equipment which will become expensive to replace. Calcium is needed for certain chemicals to properly function as well. Only use potable water that has not been treated with a water softener.

Question: I am concerned about the amount of chemicals my family is exposed to, do I really need to use as many chemicals in large amounts?

Answer: While there should be concern of over exposure to any chemical being unhealthy, spa chemicals when used correctly are designed to be effective and beneficial. In the case of spa water, the chemicals we recommend are important to protect the user from waterborne illness, including skin infections and disease causing pathogens, chemicals also help to prevent corrosion of spa components.

Question: Why isn't water chemistry damage (chemical abuse) covered under warranty?

Answer: The chemical levels and water quality of the water in the spa are directly under your control. With proper basic care the spa will provide many years of hot water relaxation. If you are unsure about water chemistry, reach out to your spa dealer.

Do's and Dont's

- Do add chemicals slowly into the front of the filter compartment/weir with jet one operating for at least 10 minutes.
- Do use special care if using baking soda to clean either the interior or exterior plastic surfaces.
- DON'T use swimming pool muriatic acid to lower pH.
- Don't splash pH increaser additives on the siding.
- **Don't Use compressed sanitizers,** The use of bromine sticks or tablets in floaters may become trapped in a lounge or cooling seat, and in some cases sink to the bottom of the spa. This may cause discoloration or stress on the spa shell.
- Don't use a floater type sanitation system as a low or no maintenance solution to your spa maintenance. Floating dispensers can become trapped in one area and cause an over sanitation (or chemical burn) of the particular area, damaging acrylic, jets, and pillows. If the dispensers setting is too high, the higher concentration can also cause chemical burn damage throughout the spa. This kind of chemical damage can be done by both bromine and chlorine sanitizers.
- Don't use a sanitizer which was not designed for spas.
- Don't use household bleach (liquid sodium hyperchlorite).
- Don't broadcast or sprinkle the chemicals onto the water surface. This method can cause chemically induced blistering on the spa surface (chemical abuse).

Bather Load

“Bather Load” is the term used to describe the number of people using a spa, combined with the length of usage, and the frequency of usage. All these factors have a great effect on the spa water. The higher the bather load, the more chemicals need to be added and a longer filtration time will be needed.

Recommendations are designed for spas with average bather load (3 to 4 people=, 15 minutes of usage, three times a week at 100 degrees). If your bather load exceeds these guidelines, and you experience water quality problems, increase the amount of filtration first, (go to the next higher filtration number) then if water quality is still not adequate, consult the advice of your Cal Spas dealer for additional chemical or system recommendations. Be sure to give them your bather load information.

Ozonator

The ozone generator releases ozone into the spa water. You will still need to test for chlorine/ bromine and occasionally replenish it to return the sanitizer level back to baseline. **For spas without a circulation pump, “Pump 1” will run at low speed and the ozonator will run during filtration.**

The spa’s control system is factory programmed with one filter cycle that will run in the evening, aligning with lower energy rates in that time slot. The time and duration of the filter cycle can be set according to your needs. In addition, a second filter cycles can be enabled. Filtration time may need to be increased with a heavy bather load.

Make sure water diverter valves are turned all the way to the left or right, and never left in the center position during filtration cycles. When the diverter valve is in the center position, there is not enough suction from the pump in order to inject ozone into the spa. The ozonator will generate ozone, but it would not be injected into the water effectively.

Troubleshooting Water Clarity

Problem	Probable Causes	Possible Solutions
Cloudy Water	<ul style="list-style-type: none"> • Dirty Filter • Excessive oils/ Organic matter • Improper sanitation • Suspended particles/organic matter • Overused or old water 	<ul style="list-style-type: none"> • Clean filter • Shock spa with sanitizer • Add sanitizer • Adjust pH and/or alkalinity to recommended range • Run jet pump and clean filter • Drain and refill spa
Water Odor	<ul style="list-style-type: none"> • Excessive organics in water • Improper sanitation • Low pH 	<ul style="list-style-type: none"> • Shock spa with sanitizer • Add sanitizer • Adjust pH to recommended range
Musty Odor	<ul style="list-style-type: none"> • Bacteria or algae growth 	<ul style="list-style-type: none"> • Shock spa with sanitizer • Adjust pH to recommended range

Problem	Probable Causes	Possible Solutions
Organic Buildup/ Scum Ring Around Spa	<ul style="list-style-type: none"> Buildup of oils and dirt 	<ul style="list-style-type: none"> Wipe off scum with clean rag - if severe, drain the spa, use a spa surface and tile cleaner to remove the scum and refill the spa
Algae Growth	<ul style="list-style-type: none"> High pH Low sanitizer level 	<ul style="list-style-type: none"> Shock spa with sanitizer if problem is visible or persistent, drain, clean and refill the spa
Eye Irritation	<ul style="list-style-type: none"> Low pH Low sanitizer level 	<ul style="list-style-type: none"> Adjust pH Shock spa with sanitizer and maintain sanitizer level
Skin Irritation/ Rash	<ul style="list-style-type: none"> Unsanitary water Free chlorine level above 5ppm 	<ul style="list-style-type: none"> Shock spa with sanitizer and maintain sanitizer level Allow free chlorine level to drop below 5 ppm before spa use
Stains	<ul style="list-style-type: none"> Total alkalinity and/or pH is too low High iron or copper in source water 	<ul style="list-style-type: none"> Adjust total alkalinity and/or pH Use a stain and scale inhibitor
Scale	<ul style="list-style-type: none"> High calcium content in water - total alkalinity and pH too high 	<ul style="list-style-type: none"> Adjust total alkalinity and pH - If scale requires removal, drain the spa, scrub off the scale, refill the spa and balance water Use a stain and scale inhibitor

Chemical Abuse

Chemical abuse is defined as negligent/careless use of both recommended spa chemicals, and use of prohibited chemicals. The spa shell is designed to last for many years, but when the shell is exposed to excessive chemicals, or improper chemical application; this can cause reactions on the shell that can cause pitting, cracks, bubbling, and other blemishes on the shell.

Spa jets, pillows, and other components are designed to withstand sanitizer levels within the range mentioned in this manual. Excessive sanitizer use will cause oxidation of the interior of the spas metals and other components, which can cause rust/oxidation of jets, deterioration of spa pillows, speakers and plastics, and damage/oxidation of the spa cover.

Components & materials damaged by chemical abuse are not covered under warranty. Depending on the extent of damage the entire spa warranty can be voided, as stated in the limited warranty.



Removing and Re-seating Pillows

You can remove the pillows for cleaning and maintenance quickly and easily. This method works for all pillow types.

Grab the lower edge of the pillow with both hands and firmly pull up, as you do this the pillow inserts will pop out of the holes.

Re-seat the pillows by aligning the pillow inserts with the holes and striking the pillow hard enough for the insert pegs to pop back in place.



Jet Removal and Replacement

Jets can be easily removed for cleaning.

Grasp the outer lip/rip of the jet and turn it counter-clockwise until it completely stops, you may feel the jet loosen and pop out a bit, pull the jet outward. The jet will be very snug and may require additional turning force to pop-out. **DO NOT PRY OUT JETS**

To replace the jet, place it in the fitting and turn clockwise until it click into place and can be rotated freely to open and close water flow again.

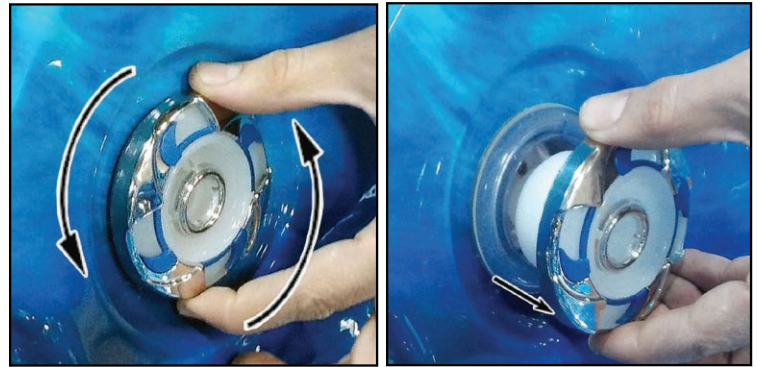

Note: have the jets turned off when removing jet inserts, it will be easier to remove when there is no water flow through it.

The spa cover can be considered one of the most important parts of your spa. The spa cover helps retain the heat inside of your spa in all different types of weather. The cover works as a lid on a thermos, when the spa is not in use the cover helps lower the amount of time the spas heater has to run for. Using the cover will help lower your operating cost of your spa when the spa is not in use.

Note: The cover is constructed of rigid foam and metal, but it is not meant to support weight for your safety, do not sit, stand, or lie on the cover, nor should you place objects on top of the spa cover

- Covered spas will protect your spas finish from the suns ultraviolet rays.
- You are required to use the spa cover to maintain warranty coverage.
- Covering your spa prevents children or pets from drowning in your spa.

Step 1

Place cover on spa. Make sure it is correctly positioned, with the skirt of the cover wrapping over your spa shell. This helps prevent blistering and cracking from sun exposure.



Step 2

Position the tie-down hardware (attached to the straps of your cover) on the side of the spa so they are easily reached by the cover tie-down straps.



Step 3

With the straps pulled tight (but not overly tight), lightly pre-drill the location for screw placement. Gently drill 3 holes - one for each screw slot in the lock.

Note: Use a low torque drill, or use the lowest setting on your drill, do not drill in the screw all the way as the corners are designed with an air pocket inside to retain heat inside of your spa. Too much force lay deform the shape of the corner and would not look as appealing.

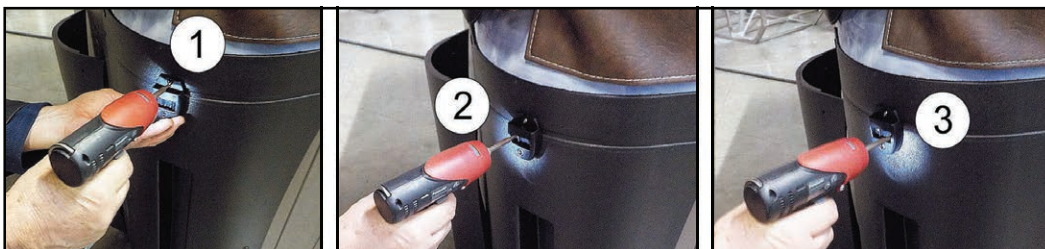

Note: Illustrated corners may appear differently to the ones on your spa.

Step 4 Use a screwdriver to finish screwing in the three screws, repeat this process for the remaining 3 corners.



Step 5 Keep the cover fastened down at all times when not in use, locking hardware may be locked with a key (provided in the packaging of the spa cover)



Step 6 The provided key will allow you to lock down your spa cover. We recommend locking your spa cover when the spa is not in use. Store your key somewhere safe, away from children.



WARNING
AVOID
DROWNING
RISK

**FAILURE TO FOLLOW INSTRUCTIONS MAY RESULT IN INJURY OR DROWNING
NON-SECURED OR IMPROPERLY SECURED COVERS ARE A HAZARD.
REMOVE COVER COMPLETELY BEFORE ENTRY OF BATHERS.
ENTRAPMENT POSSIBLE.
KEEP COVER ON SPA AND LOCKED WHEN NOT IN USE**



Your spa should be drained every four to six months for cleaning and maintenance and refilled with fresh tap water. Before you begin turn the power off to the spa at the breaker and remove your filters.

Step 1. Locate Your Drain

Pull the knob out of the cabinet. The cabinet drain is screwed into the drain pull knob.



Step 2. Remove the cap

Make sure the valve is in the closed position, then unscrew and remove the cap.



Step 3. Connect Valve to a Hose

Attach a garden hose to the hose-bib fixture. Place the other end of the garden hose where you would like the water to drain too.

Step 4. Drain the Spa

Turn the valve on the hose-bib fixture to open the drain. When the spa has drained completely, turn the valve on the hose-bib fixture, remove the hose and replace the cap.

Winterizing (Cold Climate Draining)

Depending on your region in your country, the temperature could drop below 32F(0°C). If you are one of those regions, we recommend that you always have your spa full of water and running at normal spa temperatures between 80°F - 100°F (26.7°C - 37.8°C). This will help reduce the risk of water freezing in your spa and inside of the spa equipment.

WARNING: If you find the need to drain your spa, be aware of the potential risk of water freezing in your spas equipment and plumbing, even if the directions below are followed perfectly, there is no guarantee that your spa will not suffer freeze damage. Freeze damage is not covered under warranty.

- 1 - Open all filter covers.
- 2 - Remove the filter baskets and filters
- 3 - Drain your spa completely.
- 4 - Vacuum water from the spa's main drain fitting with a wet/dry vacuum
- 5 - Open the bleeder valves on the pumps
- 6 - For spas equipped with a UV light, loosen the quarts tube nut to let the water drain from the UV light chamber.
- 7 - Disconnect the unions from both sides of the pump.
- 8 - Blow out any remaining water out of the jets, suctions, filter canister, and equipment area with a wet/dry shop vac.
- 9 - When it has completely finished draining, replace the quarts tube in the UV lamp chamber, and tighten the nut. Close the bleeder valves and re-connect the unions on the pumps.
- 10 - Replace the filter basket and filters.
- 11 - Cover your spa with a good spa cover and an all weather tarp to ensure neither rain nor snow enters the spa.



Note: Do not use antifreeze to treat your spa, irreversible damage will occur to seals and spa finish.

Cleaning and Replacing the Filter

Filtration is one of the most important steps you can take to ensure clean, clear water. It is far less expensive to fix water clarity problems by properly filtering your spa than using excessive amounts of chemicals, excessive filtration times, or by water replacement.

Vacation Care

You can leave your spa unattended for up to two weeks if you follow these instructions

Note: Always lock your spa cover using the cover locks if you plan to be away from home and the spa is filled with water, these instructions will help maintain your water quality for up to two weeks. Use of the spa during this period of time by guests or family can affect the clarity and conditions of the spa.

Select a low range temperature of 80F (27C)

Note: Platinum Spas & Escape Spas with Gecko systems, Refer to filtration mode "Away From Home"

1. Use a test strip, Adjust pH, AK, and CH if necessary.
2. Shock the spa water with your selected sanitizer (Add either bromine or chlorine)
3. Lock the spa cover to the cover locks.
4. When you return, test the water again and adjust pH and shock the water again.

If you will not be using your spa for longer than 14 days and the spa is not able to be maintained, we recommend following the cold climate procedure to prevent algae growth, bacteria, and spa damage.

Spa Cover and Pillows

Due to constant punishment your spa cover and pillow receive, you should protect them by applying a vinyl and leather cleaner as part of your monthly maintenance plan. Use a product that is designed specific to spa covers and pillows, to protect them from UV ray damage without leaving an oily residue. Contact your spa dealer for recommendations.

Warning DO NOT use any kind of automotive vinyl protectants on spa pillows or covers (ex. Armor all, Meguiar's, etc). These products are oil based and will leave an oily layer on your water line and will cause severe water clarity issues that require hours of work to correct, including multiple flushes of the system.

Spa Shell

Each time the spa is drained, before the spa is refilled it should be cleaned with an all purpose cleaner, or a mild detergent, followed up with a surface protectant. Do not use abrasive chemicals or cleaning tools as it may scratch the acrylic. Use a non oil based protectant designed for spas to protect the finish from mineral build up associated with normal spa use.

Using the Freedom Sound System

The Freedom Sound System™ entertainment option contains a Bluetooth enabled speaker system that is available for certain Cal Spa models. Any Bluetooth-enabled device can be used to play audio through your spa. Before you can use the sound system, you will need to pair the speakers to your smart device via Bluetooth. The Freedom Sound System will respond to equalizer (EQ) from your mobile device, use your devices settings to adjust bass, treble, or certain frequencies you wish to amplify.

On your mobile device, open the settings and select Bluetooth, the device will begin to scan for available devices. Bluetooth signal is the strongest when you are next to the spa with a range of 5-10 feet based on conditions and the position of the spa.

The sound system will appear as "Aquatic AV" on your mobile device. Apple devices may require a password to pair , use "0000" to pair the spa to your device. Android devices will pair at initial selection from your devices Bluetooth menu.

Once your device is paired and connected, all sounds from your device will be played through the sound system, including system sounds and telephone.

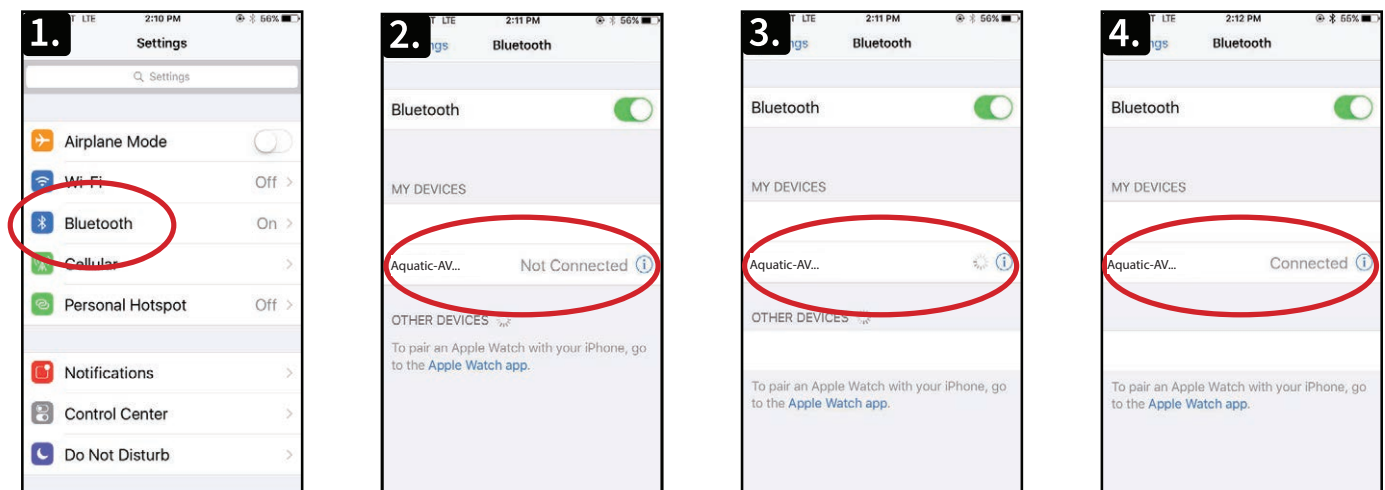



The fastest tool to find replacement parts and accessories

Buying replacement filters, parts, or accessories is part of spa ownership, but finding commonly replaced or ordered parts for your spa model is made easy, and just a few clicks away. Using your spa serial number, you may look up and find your exact spa model and find these components.

Website: WWW.QUICKSPAPARTS.COM

**Note: Images in this guide are for example purposes, no deals or offers shown in these images are accurate. Always check our website for promotions or exclusive offers/discounts

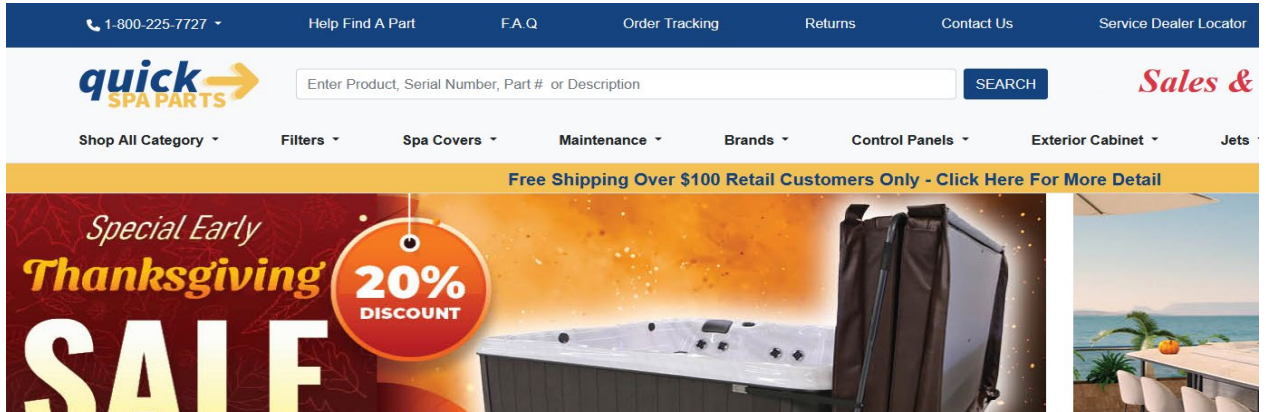

Quickspaparts is our factory parts website, where you can get multiple components for your spa, including common universal components. We intend for our spas to last you for many years to come, therefore we want to ensure the process of ordering common parts, is as easy as it can get.

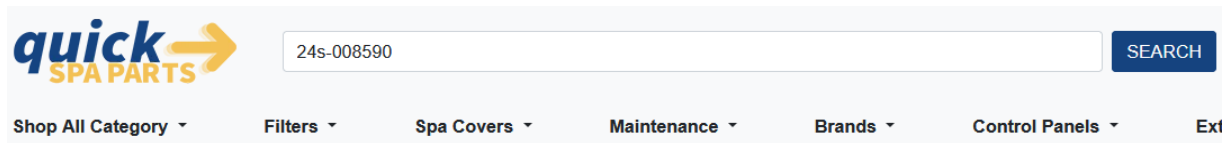

Using your spas serial number (located in the front cabinet, on the bottom right), type this serial number in the quick spa parts search bar to find general components for your spa.

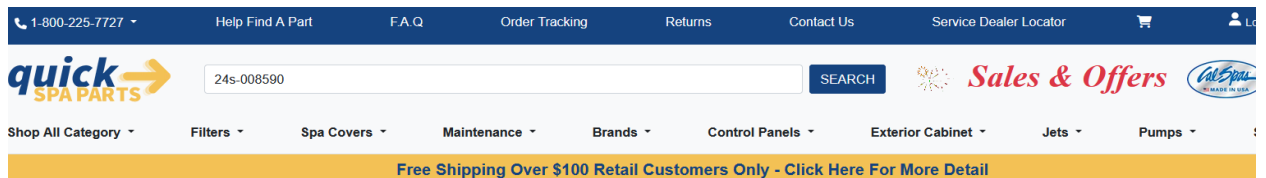

Search Results for Serial Number 24S-008590

Model# L-S24-EC867L-24 Serial# 24S-008590 2024 EC-867L-24 67 JETS, LOUNGER, ESCAPE SPAS	<input type="checkbox"/> Accessories (1)	<input type="checkbox"/> Cabinet (5)	<input type="checkbox"/> Circuit Boards (1)	<input type="checkbox"/> Control Boxes (1)
	<input type="checkbox"/> Control Panels (2)	<input type="checkbox"/> Covers (1)	<input type="checkbox"/> Electrical (0)	<input type="checkbox"/> Entertainment (2)
	<input type="checkbox"/> Filter Parts (3)	<input type="checkbox"/> Filters (0)	<input type="checkbox"/> Heaters (1)	<input type="checkbox"/> Jets (17)
	<input type="checkbox"/> Lights (7)	<input type="checkbox"/> Parts (1)	<input type="checkbox"/> Pillows (1)	<input type="checkbox"/> Plumbing (43)
	<input type="checkbox"/> Pumps (3)			

Using your serial number will bring up common components that most spa owners would search for when replacing components. Not all components will appear in the search results, if that is the case reach out to your spa dealer for ordering certain components.

Note: If you dealer is no longer in service, or you have inherited or purchased a used spa. You can contact us directly at customerservice@calspas.com with your spa serial number and an image of the needed component.

<p>1 to 3 ext cord</p> <p>LIT16100335</p>	
<p>1 to 1 port ext cord</p> <p>LIT16100338</p>	
<p>Interior Light with Logic (7 LEDs)</p> <p>LIT16100337</p>	
<p>Interior Light without Logic (7 LEDs)</p> <p>LIT16100333</p>	
<p>Main Light Housing (LED Lens, nut fitting, grommet/gasket)</p> <p>LIT630-7048</p>	
<p>Filter Cartridge 75 sqft</p> <p>FIL517-4619LC-DSG</p>	
<p>Filter Cartridge 50 sqft</p> <p>FIL50-%D13H15FCT-3</p>	



<p>SGMS Teleweir Filter, 50 Sq. Ft. 6 Scallop, w/out Cartridge, 2" Check Valve, HLG (517-4609LC-HLG)</p> <p>FIL517-4609LC-HLG</p>	<p>FILTER UP-ANCHOR SKIMMER WHITE (Pantone PMS 2330C) (L-2124)</p> <p>FIL11700330</p>
<p>SGMS Ultra Skim Filter, 75 Sq. Ft. w/out Weir, with Cartridge, HLG (517-4619LC-HLG)</p> <p>FIL517-4619LC-HLG</p>	<p>3 Inch Jet Insert (3DR) Mini Storm Internal, Twister, Vector X Style HLG</p> <p>PLUCS2441049S-HLG</p>
<p>FILTER PLATE WHITE WITH CAL SPA LOGO EVA (L-4235)</p> <p>FIL11700331</p>	
<p>FILTER CARTRIDGE 50 SQFT,</p> <p>FIL11700338</p>	
<p>5 Inch Jet Insert Power Storm Internal, Roto, HLG Vector X Style, Metal, With O-Ring on Diffuser</p> <p>PLUCS2247049S-HLG</p>	
<p>5 inch Jet Insert - (5T) Adjustable Whirlpool Internal, Vector X Style, Metal</p> <p>PLUCS2394029S-HLG</p>	
<p>Cal Spas Cascade Pillow (Off White)</p> <p>ACC01401103-W</p>	



<p>2 Inch Jet Insert (2D) Cluster Storm Internal, Directional, Vector X Style, Assy</p> <p>PLUCS2440019S-HLG</p>	
<p>5 inch Jet Insert - (5T) Adjustable Whirlpool Internal, Vector X Style, Metal</p> <p>PLUCS2440029S-HLG</p>	
<p>3 Inch Jet Insert (3D) Mini Storm Internal, Multi-Massage, Vector X Style, Metal, With O-Ring on Diffuser</p> <p>PLUCS2445059S-HLG</p>	
<p>3 Inch Jet Insert (3D) Mini Storm Directional Metal Eyeball Int. Vector X Style Assy</p> <p>PLUCS2445009SSH LG</p>	
<p>4.5 Inch Poly Storm Internal, Metal Directional E/B, Vector X Style, Metal, With O-Ring on Diffuser HLG</p> <p>PLUCS2446009SSH LG</p>	
<p>4.5 Inch Jet Insert Poly Storm Internal, Metal Roto E/B - HLG Vector X Style, Metal, With O-Ring on Diffuser</p> <p>PLUCS2446029SSH LG</p>	
<p>Cal Spas Y- Pillow (Off White)</p> <p>ACC01401102-W</p>	



<p>4.5 inch Jet Insert Poly Storm Internal, Waterway Roto E/B - HLG Vector X Style, Metal, With O-Ring on Diffuser</p> <p>PLUCS2446039SHLG</p>	
<p>4.5 Inch Jet Insert Poly Storm Internal, Turbine, HLG Vector X Style, Metal, With O-Ring on Diffuser</p> <p>PLUCS2446069S-HLG</p>	
<p>5 Inch Jet Insert (5D) Power Storm Internal, Metal Directional E/B - HLG Vector X Style, Metal, With O-Ring on Diffuser</p> <p>PLUCS2447009SSH LG</p>	
<p>5 Inch Power Storm Internal, Tri Directional E/B - HLG Vector X Style, Metal, With O-Ring on Diffuser</p> <p>PLUCS2447019SHLG</p>	
<p>5 Inch Jet Insert Power Storm Internal, Metal Twin Roto E/B, HLG Vector X Style, Metal, With O-Ring on Diffuser</p> <p>PLUCS2447049SSH LG</p>	
<p>5 Inch Jet Insert Power Storm Internal, Turbine, HLG Vector X Style, Metal, With O-Ring on Diffuser</p> <p>PLUCS2447069S-HLG</p>	
<p>Waterfall LED Spillway 12"</p> <p>PLU21801038</p>	



<p>1 LED Light String LIT16100330</p>	 A coiled white LED light string with a single connector at the end.
<p>2 LED Light String LIT16100331</p>	 A coiled white LED light string with two connectors at the end.
<p>4 LED Light String LIT16100332</p>	 A coiled white LED light string with four connectors at the end.
<p>Spa Cover Locks and Keys ACC01800026, ACC01800020</p>	 Four black plastic spa cover locks arranged in a 2x2 grid, with two keys placed in the center.
<p>Waterfall LED Spillway, 18" Large PLU21801039</p>	 A long, rectangular, grey plastic spillway with a central circular opening. Below it are a blue and white connector and a small grey circular cap.



Replacement of Cabinet Panels

The complete selection of replacement cabinets for all models is very extensive and too lengthy for this owner's manual. To order replacement panels for your spa, visit www.quickspaparts.com

Covers

All spa covers are designed with a tapered height, angling downward from the center to the sides to drive off rain and prevent water from pooling. The covers listed below are filled with either 1 lb., 15. lbs., or 2.0 lbs. foam.

Basic

4" - 2.5"

1.5 lbs. foam



Deluxe

5" - 3"

2.0 lbs. foam

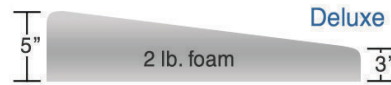

84" x 84" (7 foot spas)

Fits spa models: PL-760L, PL760B, PPL7B

	Basic	Standard
Black	COV848BBK-3	COV8484SBK-3
Grey	COV8484BG-3	COV8484SG-3
Brown	COV8484BDB-3	COV8484SDB-3

93" x 93" (8 foot spas)

Fits spa models: PL-860L, PL-861B, PL880L, PL-881B, PPL8B

	Basic	Standard	Deluxe
Black	COV9393BBK-3	COV9393SBK-3	COV9393DBK-3
Grey	COV9393BG-3	COV9393SG-3	COV9393DG-3
Brown	COV9393BDB-3	COV9393SDB-3	COV9393DDB-3

Basic Troubleshooting

The troubleshooting guidance provided here is intended to cover the most common problems a spa owner may encounter. For more in-depth troubleshooting, go to www.calspas.com/troubleshooting.

Symptom	Possible Solutions
---------	--------------------

Problems starting up

Pump won't prime	See priming instructions Pg 12
Breaker keeps shutting off	Reset the GFCI breaker. If this continues, contact your dealer or a qualified spa technician.

Power and system problems

System won't start up or breaker keeps shutting off	Power may be shut off. Turn on GFCI circuit breaker. If this continues, contact your dealer or a qualified spa technician.
Control panel doesn't respond	Turn on or reset the GFCI circuit breaker. If this does not solve the problem, contact your dealer or a qualified spa technician. If you hear the pump running but the control panel doesn't respond, contact your dealer
Spa does not turn off	Spa may be trying to heat up. Check if spa is in Ready or Rest mode In cold climates, if spa is not equipped with full foam or any kind of insulation, it will try to maintain the set temperature. Set the spa to low temperature range and set the temperature to 80°F. Spa may be in filter cycle. If it is, this is normal and no adjustment is necessary.
Message on the control panel	There may be a problem. See Diagnostic Messages

Heat problems

Spa water does not get hot	Spa may be in low temperature range. Set the spa to high temperature range. The filter may be dirty or may need to be replaced. Clean or replace the filter. The water level may be too low. Fill the spa with water level at 4 to 6 inches from the top. The temperature is not turned up high enough. Raise temperature on topside control. Cover the spa. The cover will keep heat in the spa and help keep heat from escaping. Make sure cover is on at all times when spa is not in use. The heater element may be old, deteriorated, coated with scale, or defective. Contact your dealer for more assistance. The gate valves may be partially or completely closed. NEVER OPERATE YOUR SPA WITH THE GATE VALVES CLOSED!
----------------------------	---



Symptom**Possible Solutions**

Spa overheats - temperature greater than 110°F / 43°C

Overheating can occur during summer months and may not necessarily indicate a malfunction. When it occurs, a message code may also appear on the control panel.

Temperature may be set too high. Turn the set temperature down to a lower temperature.

Filtration time may be too long. Turn the filtration cycles down during the warm months.

The spa may not be properly ventilated. Make sure the front of the spa is not blocked to allow air flow.

High speed pumps may have been running too long. Limit pump running time to no more than 15 to 30 minutes.

Water pressure problems

Low water pressure

Jet valves may be partially or fully closed. Open the jet valves.

Filter cartridge may be dirty. Clean or replace the filter.

Pump may have airlock. Remove airlock by priming spa

The suction fittings may be blocked. Remove any debris that may be blocking them.

The filter skimmer may be blocked. Remove the blockage.

Gate valves may be closed. Open gate valves. Note: Never operate your spa with the gate valves closed!

Spa may be running in filtration mode. Press JETS or JETS 1 button to turn on high speed pump.

No water pressure (no water stream from any jets)

Power may be switched off. Turn the power back on.

The pump may be defective. After you have tried all other troubleshooting, contact your dealer for assistance.

Jets surge on and off

Water level may be too low. Add water to normal level.

Pump problems

Pump runs constantly – will not shut off

There may be a problem with circuit board. Contact your dealer.

Noisy pump

The water level may be too low. Fill the spa with water level at 4 to 6 inches from the top.

Filter cartridge may be dirty. Clean or replace the filter.

Pump may have airlock. Remove airlock by priming spa

The suction fittings may be blocked. Remove any debris that may be blocking the suction fittings.

Gate valves may be closed. Open gate valves. Note: Never operate your spa with the gate valves closed!

Air may be leaking into the suction line. Contact your dealer for assistance.

Debris may be inside the pump. Contact your dealer for assistance.

Noise may be a sign of damage. Contact your dealer for service.

Symptom	Possible Solutions
Pump turns off during operation	<p>Automatic timer may have completed its cycle. Press JETS or JETS 1 button to start the cycle again.</p> <p>Pump may have overheated due to the vents on the equipment door being blocked. Make sure the front of the spa is not blocked to allow air flow.</p> <p>The pump motor may be defective. Contact your dealer for assistance.</p>
Pump has a burning smell while running	<p>A burning smell may be a sign of damage. Contact your dealer for service.</p>
Pump does not run	<p>Pump may have over heated. Let it cool for an hour and try operating the spa for a shorter time.</p> <p>Power to the spa may be shut off. Turn on or reset the GFCI circuit breaker. If this does not solve the problem, contact your dealer or a qualified spa technician.</p>

“Thermal Creep”

Cal Spas are designed with energy-efficient components and systems that are meant to sustain heat generated by the equipment, which is then cycled back into the spa water. In hot weather or in situations where the spa is set to extended run times, Thermal Creep may occur. Thermal Creep is a condition where the measured water temperature can be higher than the set temperature. To manage Thermal Creep you may:

Vent your cover. This means placing a folded cloth about ¾” (2cm) thick under all four corners of the cover before you lock the cover down.

Open your cover. Opening the cover at night will also quickly cool the water down if desired.

Open all air controls. Set your filtration cycles to run during the cooler times of the day or night.

Reduce the length of your filter cycles.

Visit your local dealer for additional guidance.

Since Thermal Creep only occurs in well-insulated hot tubs, it is not indicative of something that is wrong with your spa or its equipment.

This Page is Intentionally Blank.



LIMITED WARRANTY

This Limited Warranty is extended to the original purchaser of the spa produced by Lloyd's Material Supply company, Inc. Which Manufactures the Cal Spas brand portable spa manufactured after January 1st, 2026 and installed for residential use in the United States of America and Canada. This Warranty begins on the date of delivery of the spa, but in no event later than one year from the date of manufacture.

Platinum & Escape

Structural	Warrantied against spa shell collapse, leaks caused by the shell, or dangers of structural integrity due to defects in the spa shell.	10 Years
Shell Surface	Warrantied against spontaneous blistering, cracking, or delaminating of the interior spa shell.	7 Years
Equipment & Controls	Electrical Equipment- limited to spa pumps, standard heater, and control system/panels, are warrantied against malfunction due to defects in workmanship or materials.	5 Years
Plumbing	Warrantied against leaks/cracks due to defects in workmanship or materials	5 Years
Spa Cabinet	Warrantied against defects in workmanship or materials. Normal wear and weathering of the finish will occur naturally over time and are not defects.	5 Years
Sanitation	Salt cells & bromine generators are warrantied against defects in workmanship or materials, this includes sanitation control panels & electrical.	1 Year
Ozone/UV	Ozone Generators and UV treatment systems are warrantied against defects in workmanship and materials. (Excluding UV bulbs older than one year)	2 Years
LED Lighting	LED lights are warrantied against malfunction due to defects in workmanship and materials	2 Years
Sound System	The Freedom Sound System is warrantied against malfunction due to defects in workmanship and materials. This does not cover normal wear and tear.	1 Year
Spa Cover	The spa cover is warrantied against malfunction due to defects in workmanship and materials. This does not cover normal wear and tear.	3 Years
XL Heater	The XL Heater carries a lifetime warranty, which is based on the designed/ expected lifetime of the heating element, a warranty of 10 years.	Lifetime

Warranty for Other Components

The fuses, headrests, cal grip, labels, and filters are warrantied to be free of defects in workmanship and material at the time of delivery. All other factory-installed components not mentioned specifically, including, but not limited to the wood frame, jets, diverter valves, filter lids, and other mechanical components, are warrantied against malfunction due to defects in workmanship and material for two years from the original date of delivery. This warranty is void if the spa has endured neglect, chemical abuse, or use of unapproved chemicals or components.

Structural

This limited warranty covers defects within the spas fiberglass structural shell. This includes sudden spa shell collapse, leaking through the shell, and separation between the spa shell and spa acrylic, caused by faulty bonding. This does not include separation due to micro-abrasions, pin holes in the shell, or warping/bubbling due to sun exposure. This limited warranty does not apply when abuse of the spa shell is evident. This includes but is not limited too, heavy impact craters, fractures on the spa surface due to poor spa care, sun exposure, or reckless use of the spa, and chemical abuse of the spa. This warranty does not cover damage caused by unlevelled ground. Spas must rest on level ground, ideally on a cement slab of 3-6" of thickness depending on the spa weight. Spas that are not placed on a leveled foundation are prone to cracks, delamination, and compromised structural rigidity of the spa. It is the responsibility of the spa owner to ensure that the spas foundation is leveled and inspected before placing the spa.

Shell Surface

This limited warranty covers defects on the spas acrylic surface due to workmanship or materials. This covers wrinkles on the acrylic, blistering, peeling, delamination, or spontaneous cracking. This warranty does not cover shell damage caused by chemical abuse, improper water chemistry, excessive sun exposure, micro-abrasions, or damage caused by impacts or sharp objects. This warranty does not cover discoloration, or deterioration of the spa shell when exposed to improper chemistry levels, hard water, soft water, or chemical abuse.

Equipment and Controls

This limited warranty covers malfunction of factory installed spa control systems, spa control panels, spa heater, and spa pumps due to defects in workmanship or materials. This covers sudden control box failure, malfunction of control panels or control boxes, malfunctioning heaters, and malfunctioning spa pumps. This warranty coverage is void if the electrical installation of the spa does not follow the outlined diagrams and specifications, mentioned in this manual. Failure to properly follow the specified GFCI requirements, wire type, wire thickness, compliance with NEC guidelines and local codes will void your warranty. This warranty does not cover acts of god or nature that can damage spa equipment, such examples are flooding, lighting strikes, wildfires, or other scenarios out of the control of the manufacturer.

Plumbing

This limited warranty covers leaking of water through plumbing joints, tees, hoses, water features, and jet body grommets due to defects in workmanship and materials. This warranty does not cover damage caused by chemical abuse, improper water chemistry, or use of unapproved chemicals/sanitizers. This warranty does not cover freeze damage caused by frozen water expanding within the plumbing of the spa. The winterization procedure within this manual does not guarantee freeze damage prevention. The best method to ensure the spa does not encounter frozen water within the plumbing is to have the spa operating during the colder months of the year. This warranty does not cover freeze damage or damage to the plumbing due to acts of god and/or nature including but not limited too snowstorms, blizzards, power outages, etc. This warranty does not cover oxidation or warping of jets due to chemical abuse or exposing an empty spa to the elements with no secured cover.

Spa Cabinet

This limited warranty covers defects in workmanship and materials of spa cabinet panels. This warranty applies for warping of spa panels, cracking of corners and panels without clear impact markers, and buckling of spa panels. This warranty does not cover natural wear and tear, which occurs with plastics exposed to the sun. This warranty does not cover panel damage from excessive heat sources, calcium/water-spot build up from sprinklers or irrigation systems, or impact damage. Each claim for spa cabinets are evaluated on a case by case basis, it is the responsibility of the spa owner to acknowledge environmental factors, that can affect the maintenance of the spas cabinet panels. Using plastic spa protectants can prolong the life of your spa panels is highly recommended in high UV index climates. Deterioration/fading of color, natural wear and tear of plastic materials is expected over time, and is not considered a defect in materials. This coverage does not extend nor cover acts of god or nature that can damage spa panels, such examples are flooding, high winds, wildfires, tornadoes or other scenarios out of the control of the manufacturer

Sanitation

This limited warranty covers malfunctions of factory installed Salt Systems and Bromine generators, which are warranted against malfunction due to defects in workmanship or materials. This includes the salt cell, sanitizer control panels, bromine generator, and power supplies for Cal Salt systems. This warranty does not cover negligent operation of sanitizer systems, chemical abuse, damage caused by improper water chemistry, or disregard of specified data points for safe operation; including but not limited to, incorrect ppm levels of salts, excess operating hours of the Cal Salt cell, or improper maintenance of sanitation components. The spa filter is not a part of this warranty, and is considered a disposable item subject to regular wear and tear.

Ozone/UV Systems

This limited warranty covers malfunctions of factory installed Ozone and/or UV water treatment systems. This includes leaks through welded components, water back-flow into the ozone generator, and short circuited Ozone or UV systems. This warranty does not cover UV bulbs that are older than 10 months, the UV light must be replaced every 10-12 months as this is normal wear and tear of component. This warranty is voided if alterations/modifications of these systems are evident, or if the spa electrical connections were not installed in accordance to defined specifications within this manual, evidence of chemical abuse, and acts of god and/or nature.

Sound System

This limited warranty covers malfunctions of factory installed sound system components. This includes the sub-woofer/amplifier, speakers, speaker grills, power supply, or Bluetooth antenna. Natural wear and tear of speaker cones is not covered by this warranty, nor are deterioration of speakers exposed to chemical abuse.

Spa Cover

The spa cover is warranted against defects of materials and workmanship for the defined period mentioned in this warranty. Exposure to UV rays on untreated or poorly maintained spa covers are not covered by this warranty. It is the responsibility of the spa owner to use spa UV plastic protectants on their spa covers, especially in high UV index climates. Exposure to UV light without proper treatment leads to problems such as cracking/peeling of vinyl covers, and sudden fading of color. This warranty does not warrant against damage caused by chemical abuse, nor yellowing or oxidation of the spa cover when exposed to excess sanitizer. If a defect is found within the first 90 days of ownership, your Cal Spas dealer and Cal Spas can directly assist the spa owner filing a claim and replacing the spa cover if deemed necessary. Spa owners with spa covers past the 90 day period that are discovered to have a defect, can contact your Cal Spa dealer to begin the process of filing a claim. When filing a claim of a spa cover than is older than 90 days, this warranty will cover the material cost of issuing a new vinyl sleeve for the cover, and/or replacement foam for your cover. Shipping/freight costs are not covered in this warranty, and are the sole responsibility of the spa owner. Images of the cover from all sides including the top and underside are necessary to file a claim.

Genuine Cal Spas Parts & Accessories

This Limited Warranty is void if Lloyd's Material Supply Company, Inc., Manufacturer of the Cal Spas brand or its designated representative determines that the spa has been subjected to damage or failure due to installation of aftermarket parts that are not genuine Cal Spas branded parts and accessories. This disclaimer includes, but is not limited to filters, UV bulbs, ozone systems, salt systems, replacement parts and other accessories. Genuine Cal Spas brand parts and accessories are built to our highest standards of quality, durability and performance, and they are designed to work with your spa to ensure optimal performance and function. Only parts/components approved by Cal Spas should used when performing a warranty repair. If parts are required to complete a warranty claim, the cost of the parts are covered by this warranty. Approved labor and genuine part costs are covered when a warranty claim is approved, the cost of shipping parts/components is not covered by this warranty, and its the sole responsibility of the spa owner.

Performance

This warranty begins on the date of delivery of the spa, but in no event later than one year from the date of manufacture. To obtain service in the event of a defect covered by this Limited Warranty, notify your Cal Spas dealer or Cal spas as soon as possible and use all reasonable means to protect the spa from further damage. Upon proof of purchase, a designated service representative will correct the defect subject to the terms and conditions contained in this Limited Warranty. There will be no charge for parts or Labor to repair the defect, although providing access to affect the repair is your responsibility as the spa owner. Freight charges for replacement parts is the responsibility of the spa owner. Parts and components can be shipped to the servicing dealer or to the customer. The servicing dealer may charge the owner a travel/service fee as well as a diagnose fee if the cause of the issue is unknown, these charges are not covered under warranty. Your spa dealer nor Cal Spas is responsible for damages or costs to rebuild decks, cement structures, or other decor/structures placed against the sides of the spa. Minimum clearance of 3 feet on each side is mandatory for all spas. In the event that the spa is removed to a repair facility for repair and reinstalled, the cost of removal and re-installation will be your responsibility as the spa owner. If Lloyd's Material Supply Company Inc., The manufacture of the Cal Spa brand determines that repair of the covered defect is not feasible, it reserves the right to provide a replacement spa of equal or lesser value to the original purchase price. In such an event reasonable costs for removal of the original spa, shipping costs from the factory for the replacement spa, and delivery and installation of the replacement spa will be the responsibility of the spa owner. The replacement spa will carry the balance of the original spa's warranty. Spa covers are not included. This warranty ends either by specified time frame, owner-transfer of the spa, relocation, or installation of any component other than by the manufacture. If the desired spa is more expensive than what the spa owner originally financed or paid for, the price difference shall be paid by the spa owner. Additional costs can be incurred if the use of heavy machinery such as a crane, bulldozer, etc, is considered necessary to access, remove, or perform a repair/correction to the affected spa.

XL Heater Lifetime Warranty

This warranty covers the malfunction of an optional, factory installed specialty XL heating element, due to defects in workmanship or materials. The XL Heater is covered under a unique "Lifetime" warranty exception ; The XL heaters lifetime warranty lasts for a period of 10 years, based on the expected average lifetime of the heating element. This lifetime warranty covers the heating element for 10 years from the original date of purchase. This warranty coverage is void if the electrical installation of the spa does not follow the outlined diagrams and specifications, mentioned in this manual. Failure to properly follow the specified GFCI requirements, wire type, wire thickness, compliance with NEC guidelines and local codes will void your warranty. This warranty does not cover acts of god or nature that can damage spa equipment, such examples are flooding, lighting strikes, wildfires, or other scenarios out of the control of the manufacturer. This warranty is only eligible to the original XL heater installed inside of the spa. This warranty does not apply to replacement heaters sent through the XL heater lifetime replacement program. This warranty is void in the event of a dry fire within the control box, a dry fire falls under spa abuse due to the conditions necessary for a dry fire to occur. Dry Fires are caused by low water flow within the heater, caused by a restricted filter or obstruction, this also may occur if no water is within the heater due to an airlock.

Proration of Warranty

Units determined by the manufacture to be non-repairable will be replaced on a prorated basis with the same or a comparable unit. The owner will be charged 1% of the current retail cost for each full month of ownership from the date of purchase through the date failure is determined to be non-repairable. This charge will be waived during the first 6 months of ownership. [example]: Product failure is determined during seven months of ownership. Owner will be responsible to pay for 7% of the products current cost. As the spa owner you have the choice to replace the spa, with a spa equal to or less than the value of the originally financed/purchased spa; if the desired replacement spa is of a higher cost than the originally financed/purchased spa, the spa owner will pay the difference of price, including any percent value lost over time through the spas proration period. The cost of shipping a new spa and its installation is not covered by this warranty as stated in the "Performance" section of this warranty.

Warranty limitations

This Limited Warranty is void if Cal Spas or its designated representative determines that the spa has been subjected to alteration, neglect, misuse or abuse, or freight damage caused by the common carrier; any repairs have been attempted by anyone other than a designated representative; or if the failure is caused by accident, acts of God or other causes beyond the control of the Manufacturer including acts of nature (damage caused by animals, rodents, or other pests) are not covered by this warranty. Additionally; the limited warranty is void for spas that were subject to neglect, misuse and abuse including any installation, operation or maintenance of the spa other than in accordance with the instructions contained in the owner's manual provided with the spa, including but not limited to the failure to maintain proper water chemistry, chemical balancing, the use of abrasives or improper cleaners, and the use of non-genuine parts and accessories. This Limited Warranty does not provide coverage for any item attached to or installed on the spa after the date of manufacture or for gaining access to any component for repair or replacement. Spa units in commercial use are excluded from any coverage whatsoever. The spa owner accepts liability for repair work performed by anyone other than Lloyd's Material Supply Company Inc, or a designated Cal Spas representative. This Limited Warranty is void if damage occurs to the spa shell because of excessive heat buildup due to failure to cover a spa that is empty of water while exposed to direct sunlight.

Limitations

The manufacture disclaims all warranties, expressed or implies, in fact or in law, to the extent allowed by your State's law, including the warranty of merchantability and fitness for use, except as stated specifically herein. All warranty service must be performed by the manufacture or its designated representative using authorized Cal Spas parts. No agent, dealer, distributor, service company, or other party is authorized to change, modify, or extend the terms of this limited warranty in any manner whatsoever. The manufacture will not be responsible for any statements or representations made in any form that go beyond, are broader than, or are inconsistent with any authorized literature or specifications furnished by Cal Spas. Extended warranties or care plans offered to you by a spa dealer is an agreement strictly between the spa owner and the spa dealer, out of the control of the manufacture of Cal Spas.

Disclaimers

Lloyd's Material Supply Company, Inc., Manufacture of Cal Spas brand and its representatives shall not be liable for any injury, loss, cost, or other damage whether incidental or consequential, arising out of any defect covered by this limited warranty, including without limitation, loss of use of the spa and cost for removal of defective produce even if the manufacture was advised of the possibility of damage. The liability of the manufacture under this limited warranty, if any shall not exceed the original amount paid for the defective product. Coverage under this limited warranty shall commence as of the original date of delivery and the duration of such coverage shall not extend for any reason whatsoever beyond the stated time periods. These disclaimers shall be equally applicable to any service provided by the manufacture and its designated representatives.

This limited warranty gives you specific legal rights. You may also have other rights that vary from state to state depending on consumer regulations. Some states do not allow limitations on how long an implied warranty lasts, so this time limitation may not apply to you.

Additional Disclaimers

Spa owners who have purchased a Cal Spa, and the spas final resting place is not in the United States or Canada, Cal Spas will be able to send components and parts directly to the spa customer if the original Cal Spa dealer is not within range of the spa. It is the responsibility of the spa owner to find a experienced electrician, plumber, or technician to perform the necessary repairs. A preliminary over the phone technical meeting with a Cal Spas representative is necessary, to ensure the experienced laborer is familiar with the spas operation, and recommend repair methods. Labor costs of a repair in such circumstances must be first approved by a Cal Spas representative, before moving forward with any repairs covered in this warranty. It is advised to request a labor quote from said experienced laborer, and to send this quote to a Cal Spas representative. If all prerequisites are met and the repair is approved, Cal Spas will reimburse the cost of labor directly to the spa owner upon completion of repairs. Reimbursements of charged labor will be sent as a check to the spa owners residence, with a varying estimated disbursement window.

For all repairs/warranty claims within the United States and Canada and other nations, may be required to send parts/components back to Cal Spas when deemed necessary. In some circumstance where shipping the component/part is necessary, Cal Spas will provide a shipping label to send the affected or requested components/parts. It is the responsibility of the spa owner to properly package and secure the package for shipping. In some circumstances only images and proof of purchase would be necessary to file a warranty claim, in such circumstances if a Cal Spas representative deems that the parts do not have to be returned, follow all local regulations and laws to properly dispose of said components.

This Page is Intentionally Blank





www.CalSpas.com

CONTACT INFORMATION

For customer service or service technicians, please contact your authorized dealer immediately. If you need additional information and/or assistance, contact

CAL SPAS

Lloyd's Material Supply Company, Inc.
Customer Service Department
1462 East Ninth Street, Pomona, CA 91766

Toll Free: 1-800-CAL-SPAS
Fax: 1-909-629-3890

LTR.2026.1010.XL
2/24/2026 Rev F